

- ① x 6
- ② x 4
- ③ x 8
- ④ x 4
- ⑤ x 2
- ⑥ x 1
- ⑦ x 1
- ⑧ x 4

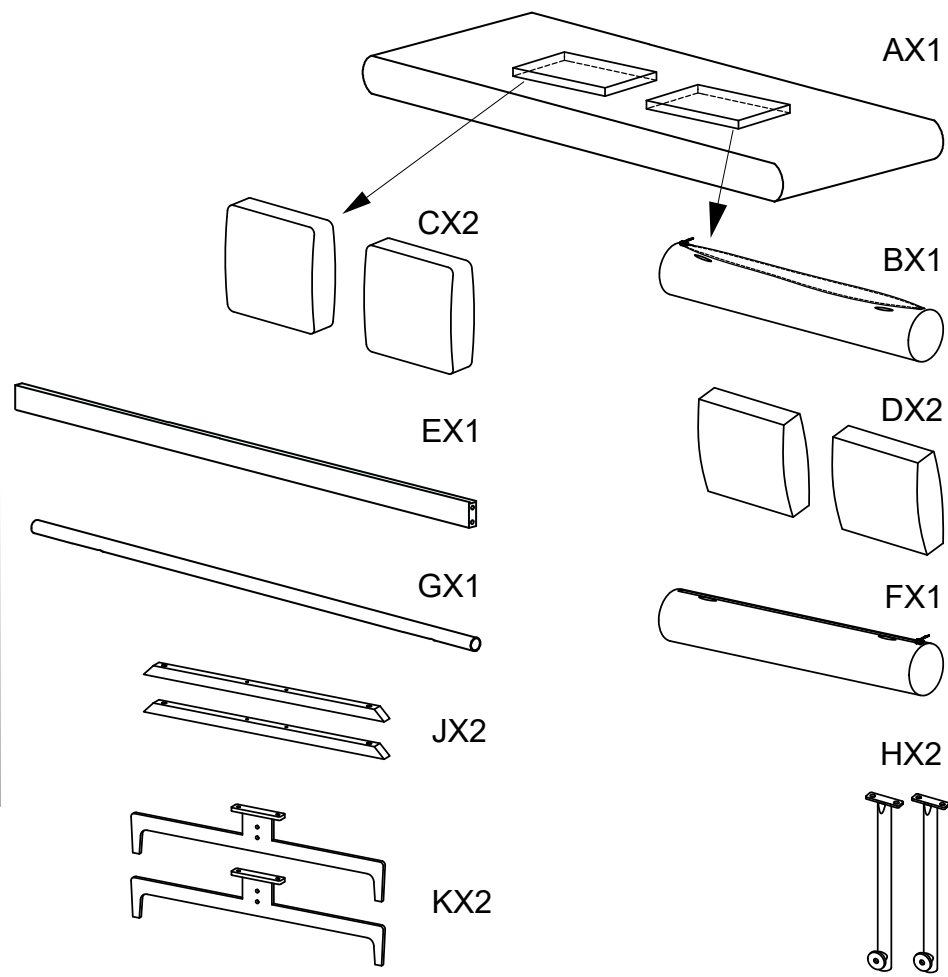

069766

2

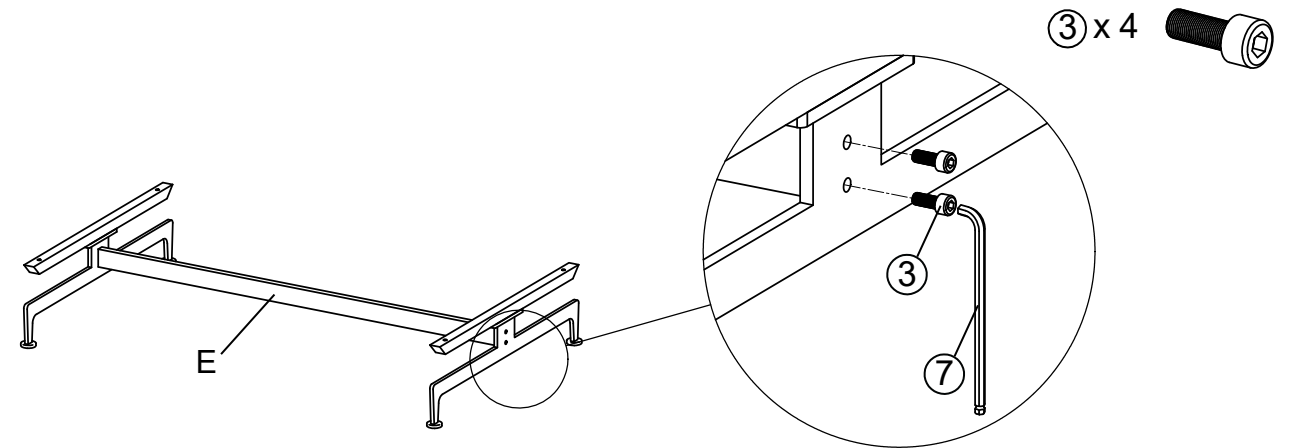

3

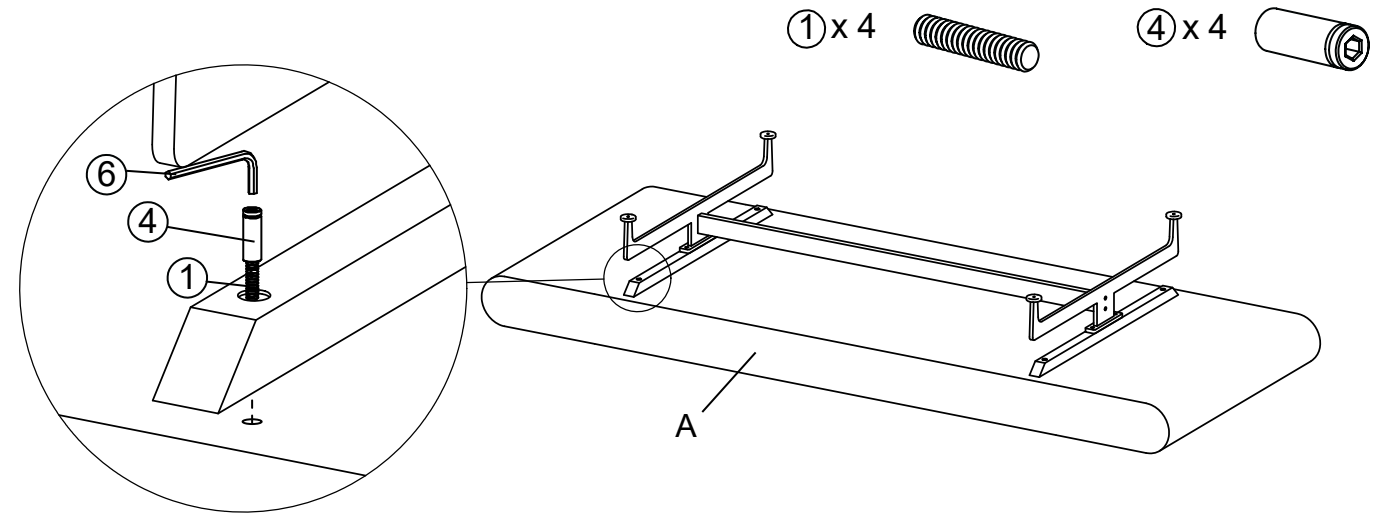

1

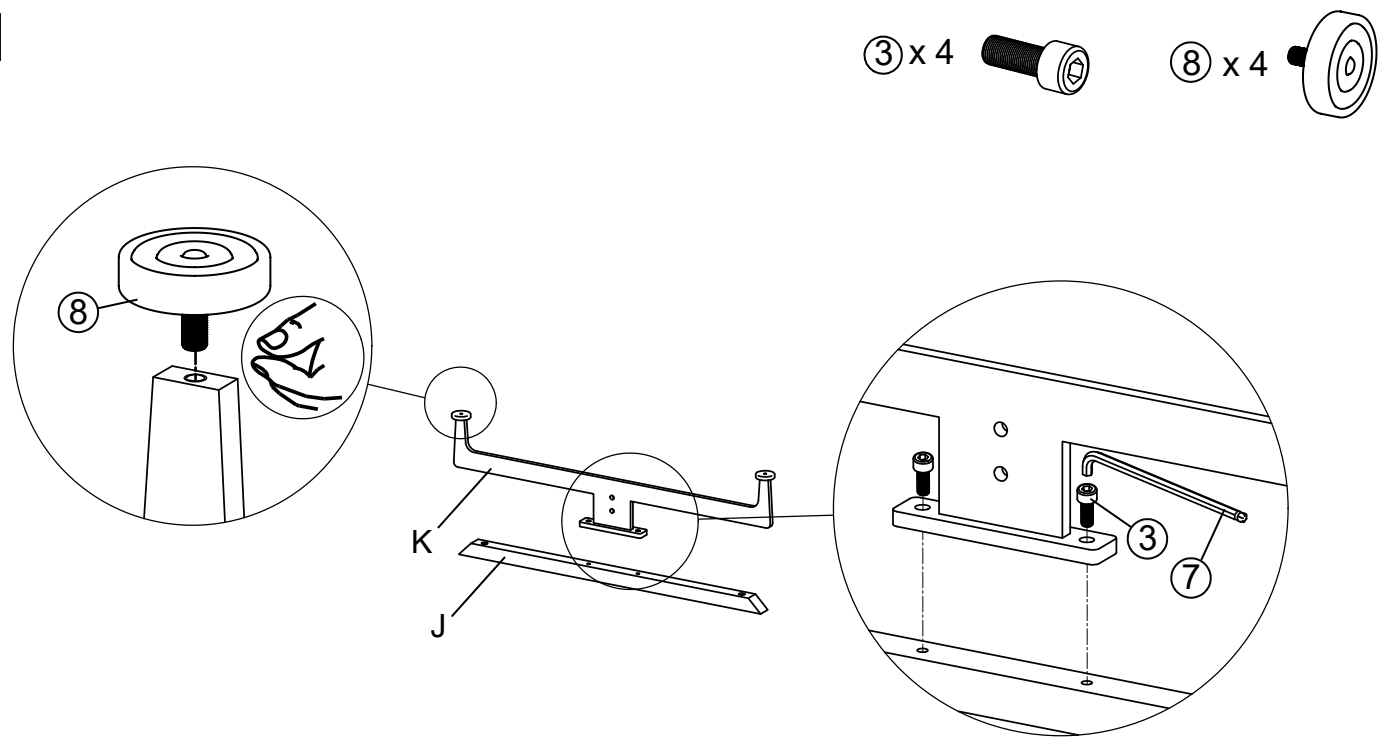

4

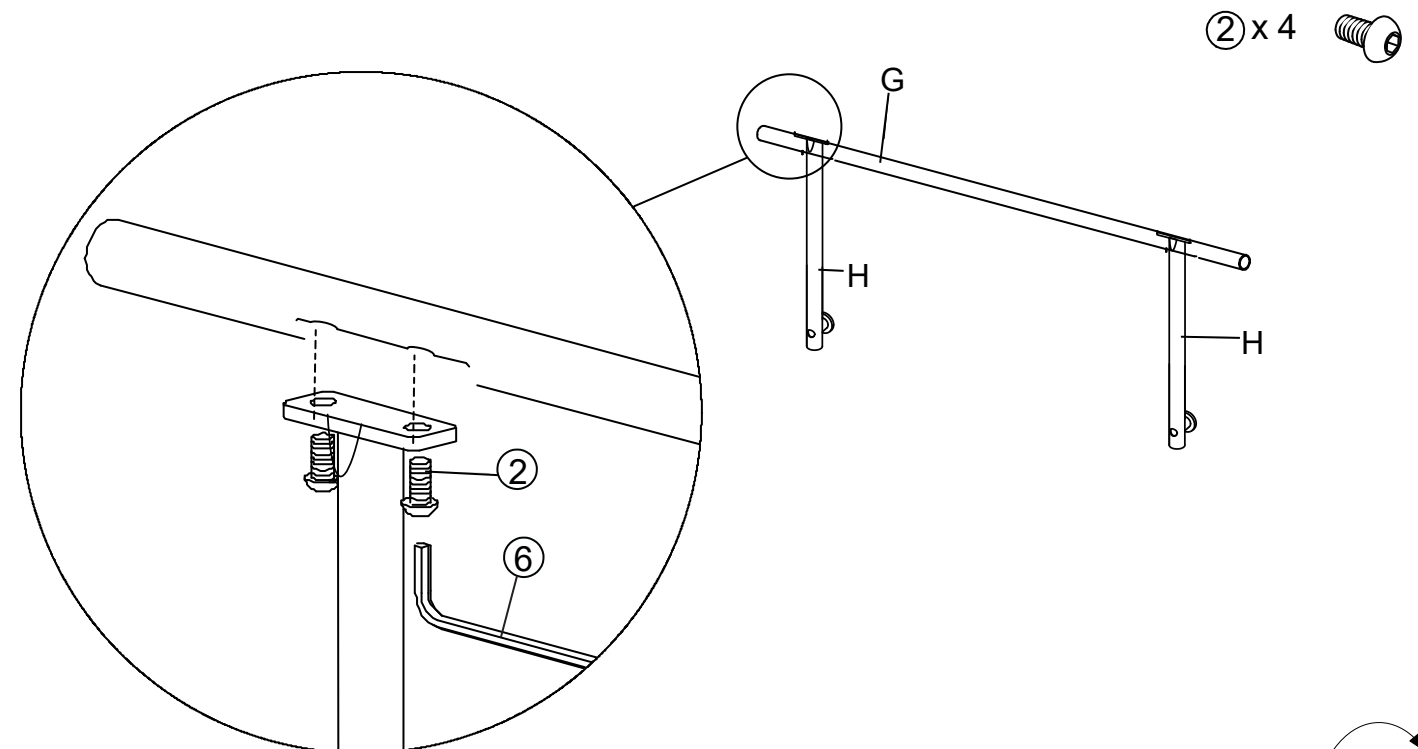

5

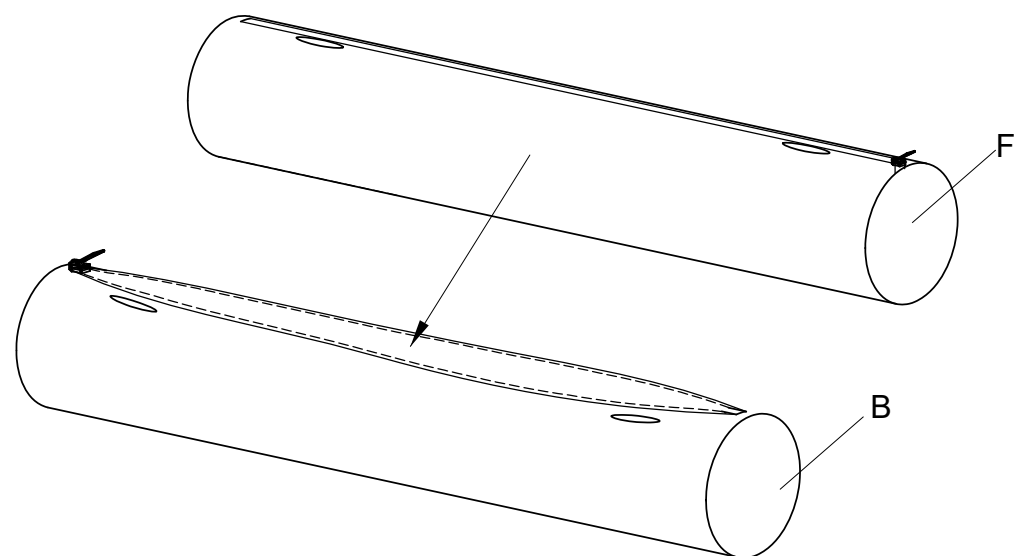

6

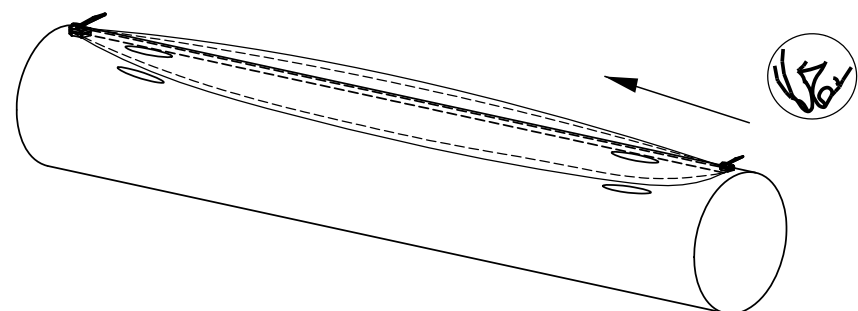

7

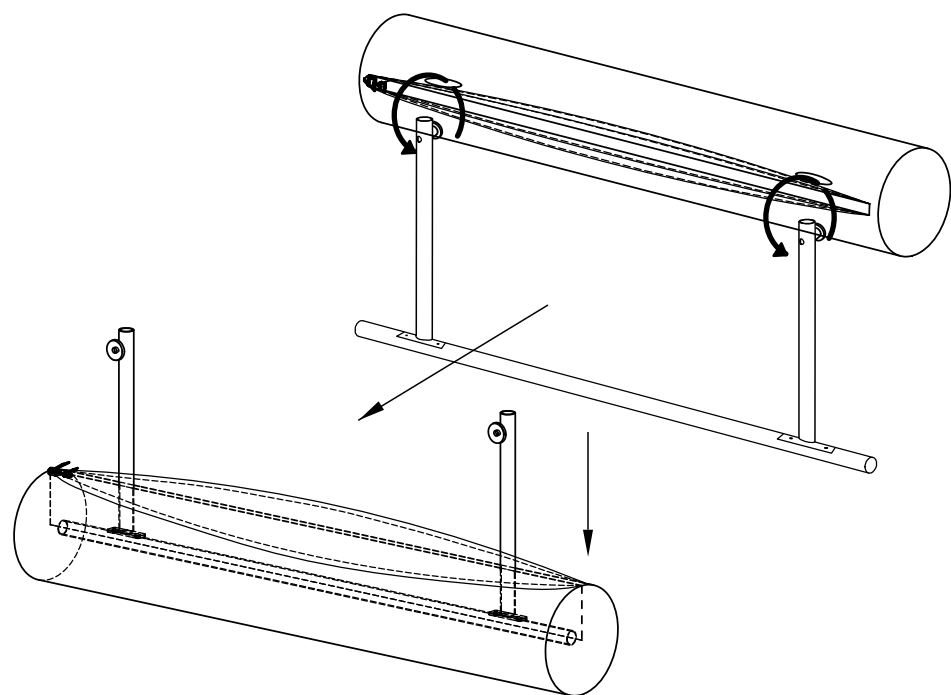

8

069766

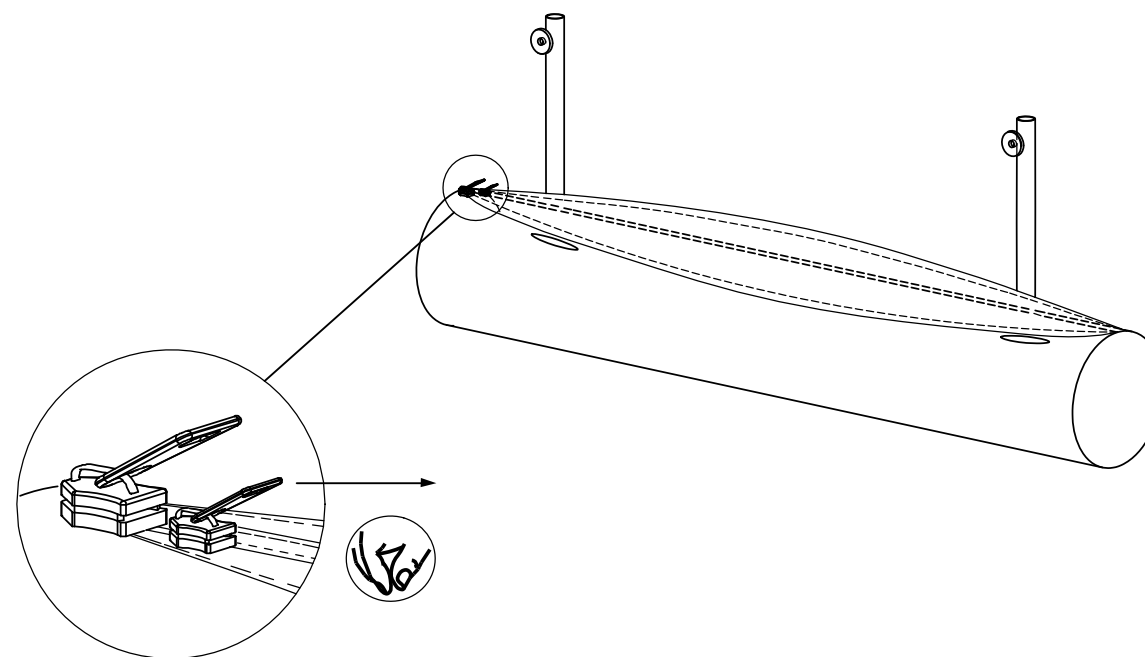

9

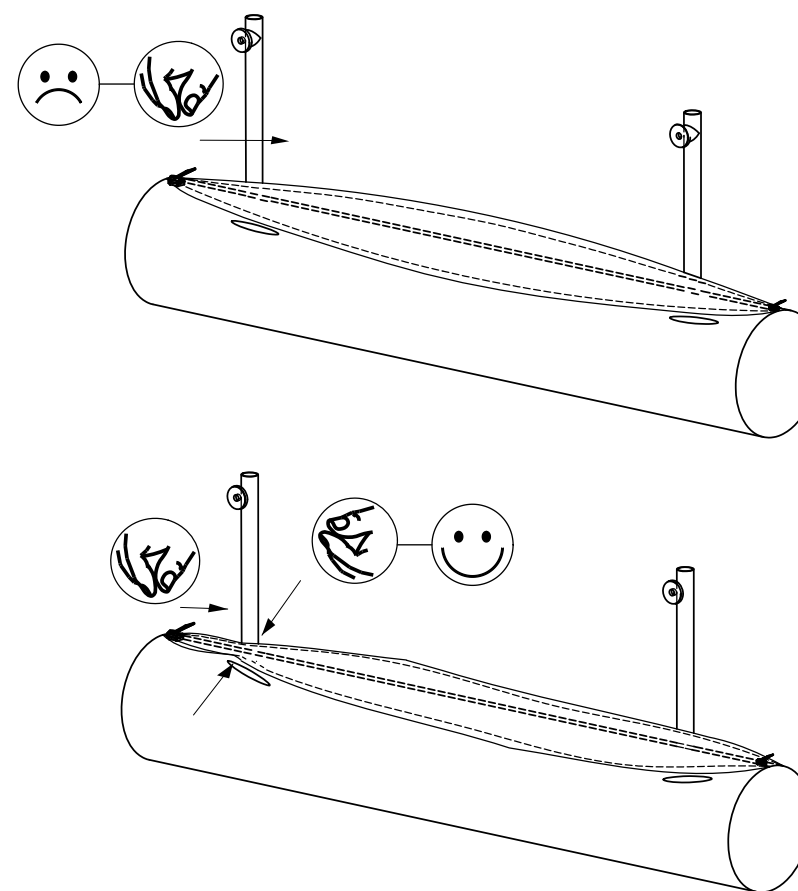

10

① x 2  ⑤ x 2 

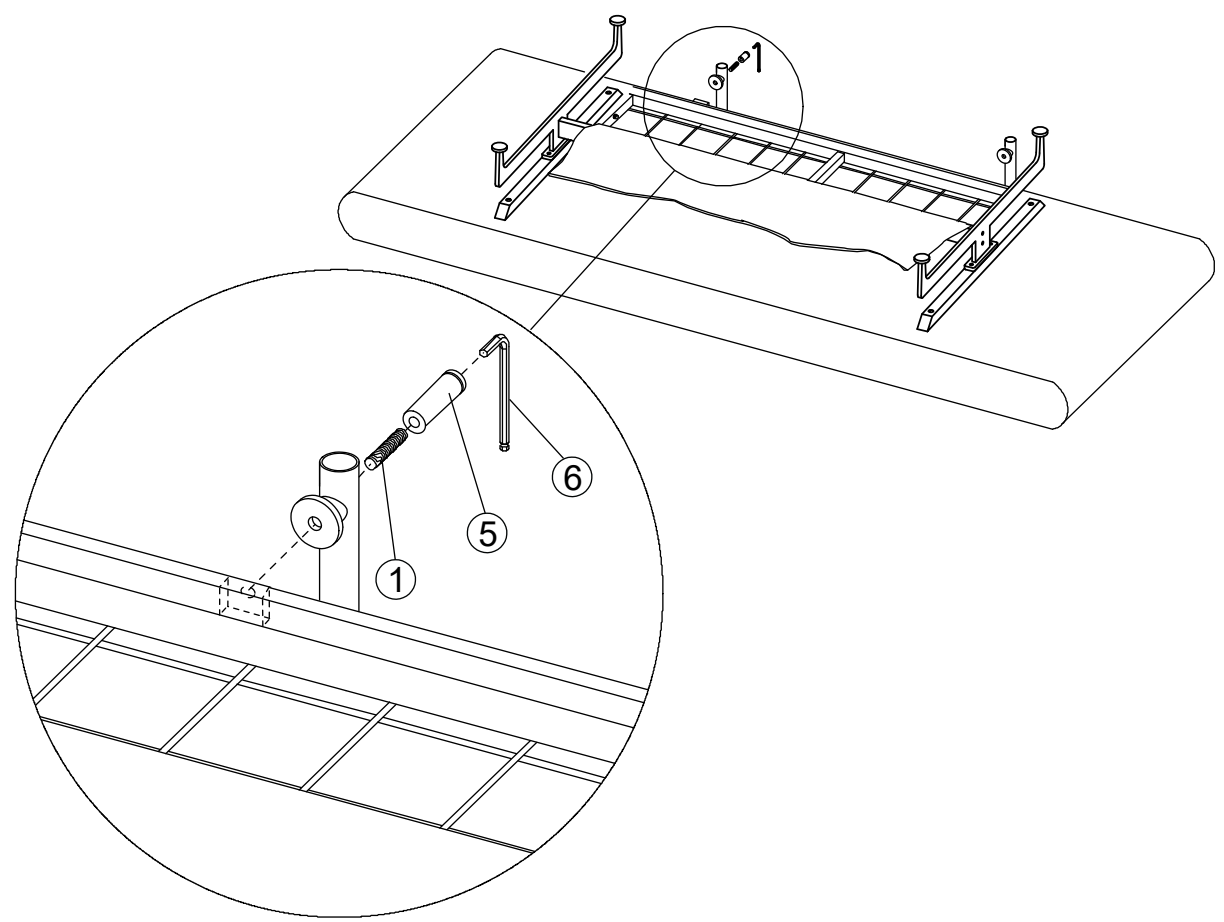

069766

1

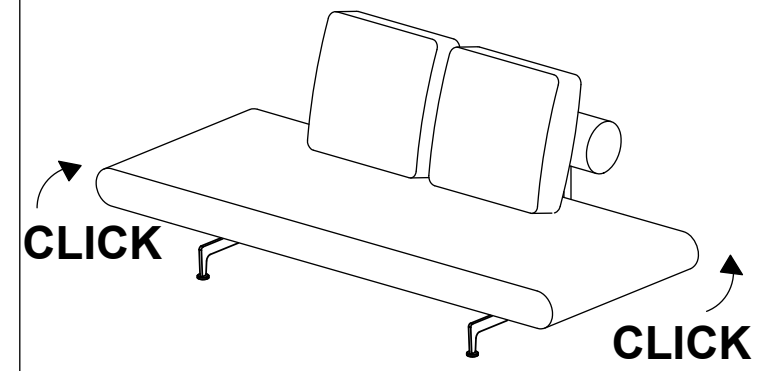

2

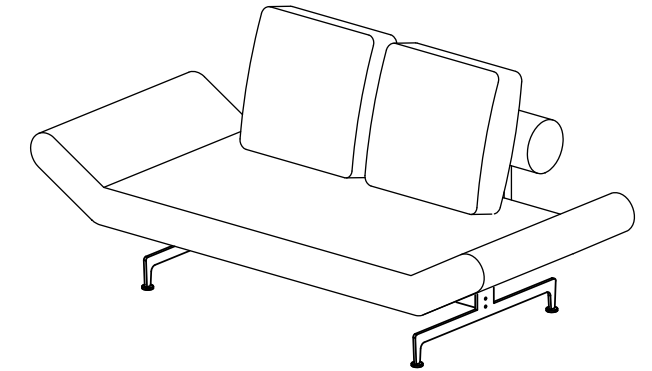

3

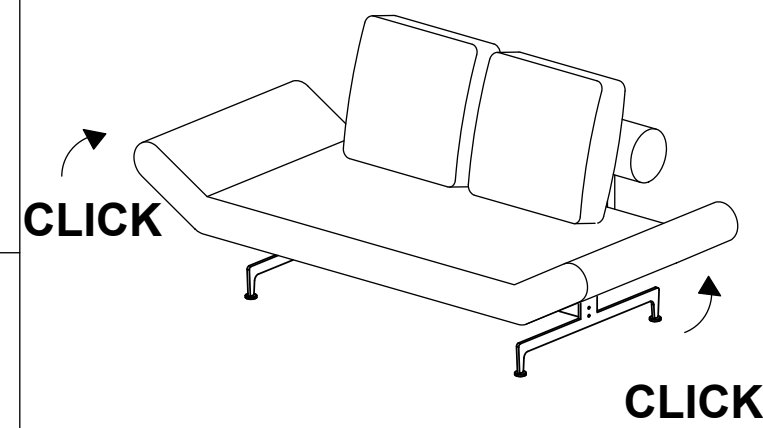

4

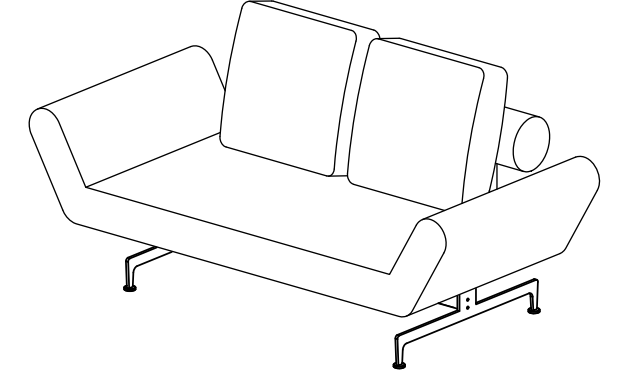

11

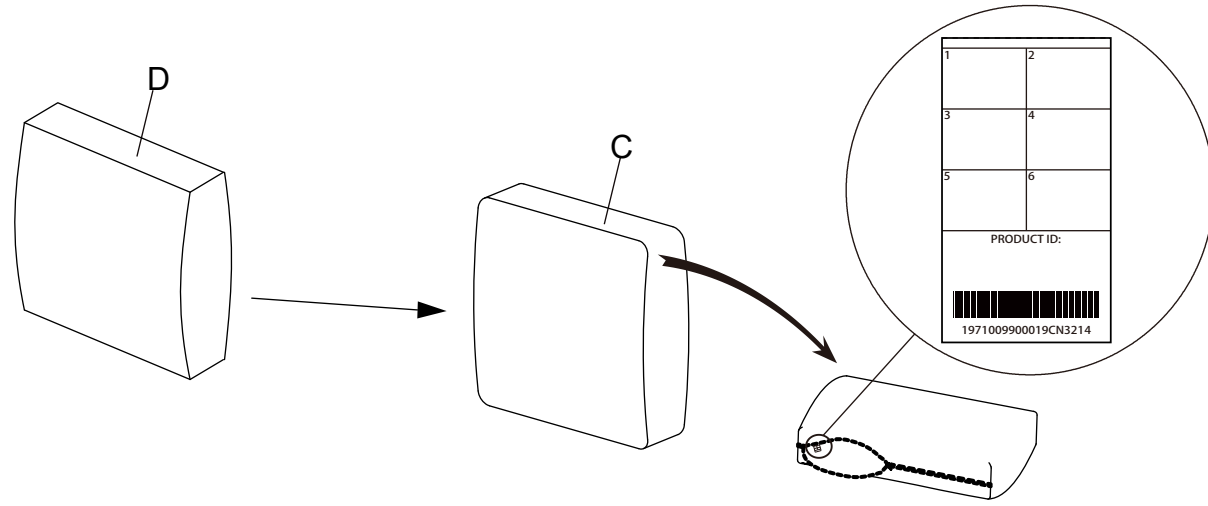

5

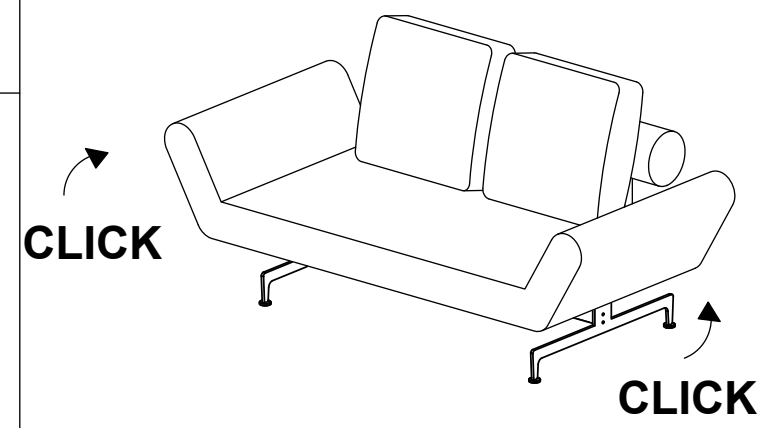

6

