

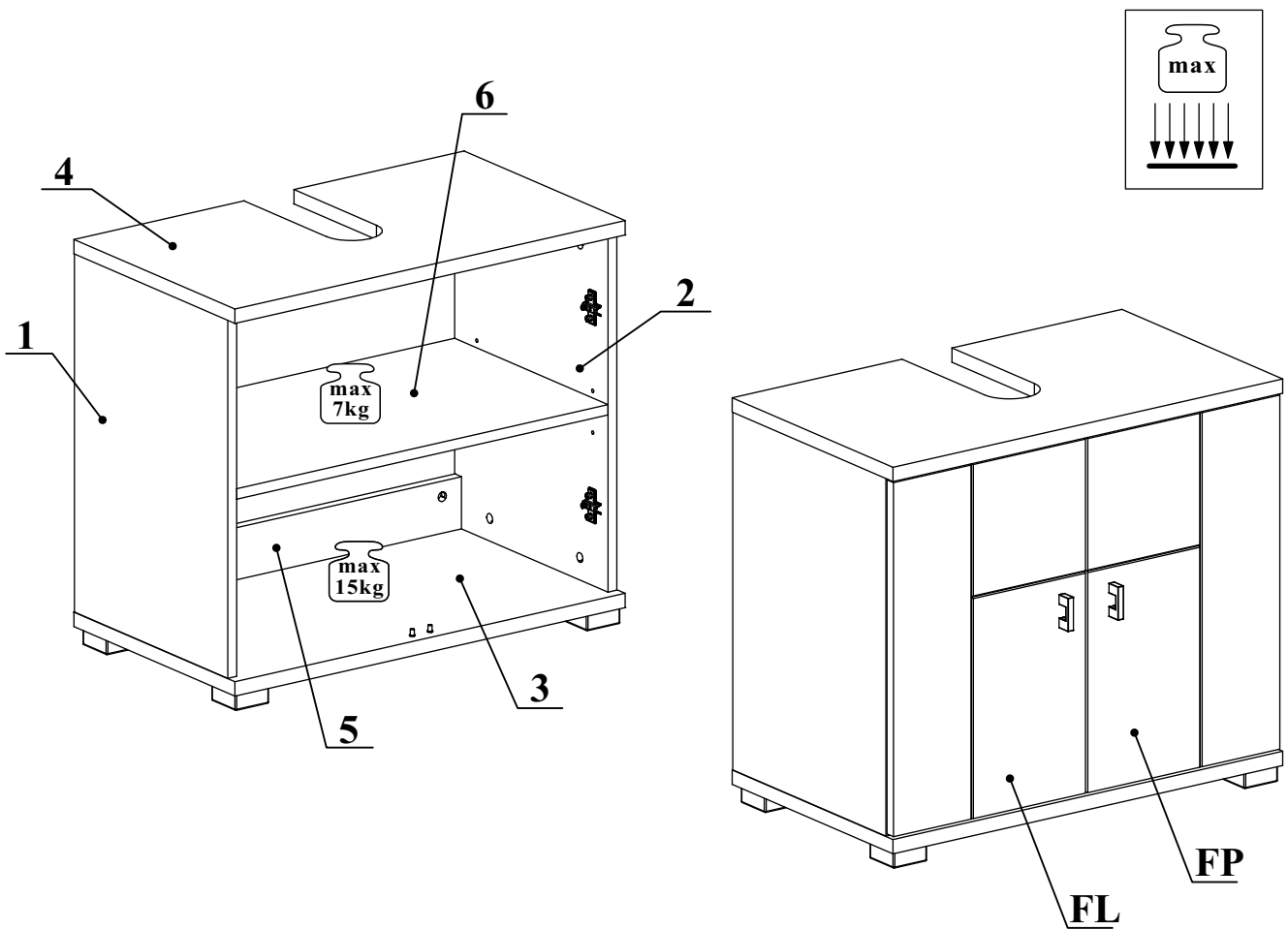

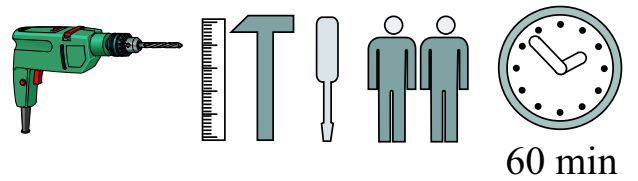

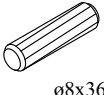

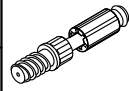

# SPALT 36-088-\_\_-6

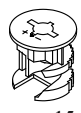
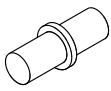
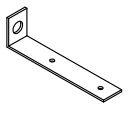
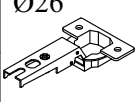
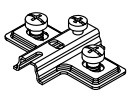

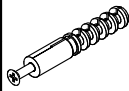
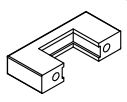
NO	Dim.		Col.-No	Qty
1	550	381	1	1
2	550	381	1	1
3	702	400	1	1
4	702	400	1	1
5	668	80	1	1
6	668	381	1	1
FL	346	544	1	1
FP	346	544	1	1

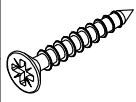
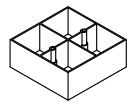

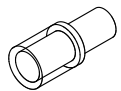
A1 x10  ø8x36	B4 x10 	G5 x10 	B5 x10  ø15x12	G7 x4 	L1 x2 
E1 x4 Ø26  H=0	E2 x4  H=0	D10 x12  USØ3,5x13	KR1 x2 	W32 x2  L-32mm.	D24 x4  USØ4x30
D6 x8  USØ3,5x30	ST3 x4 	G2 x1 	G20 x4 		

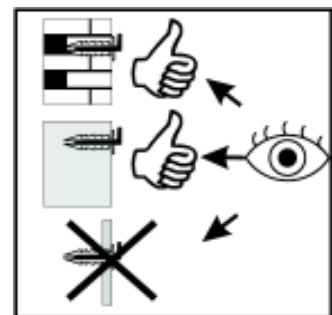
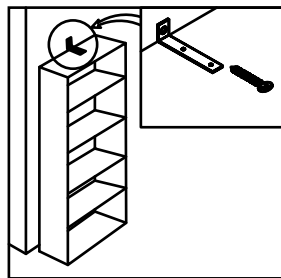
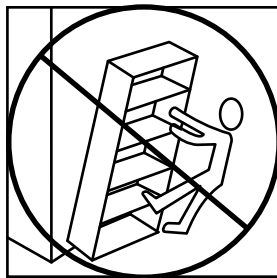
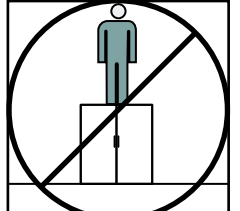
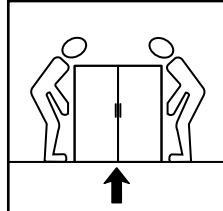
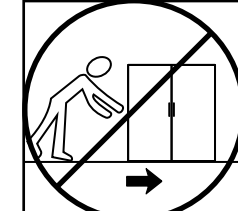
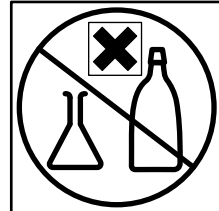
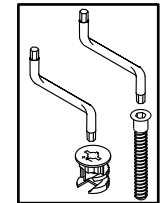
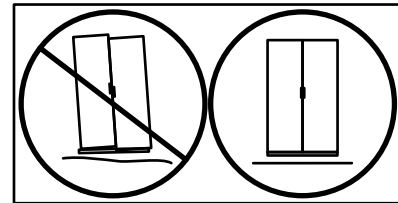
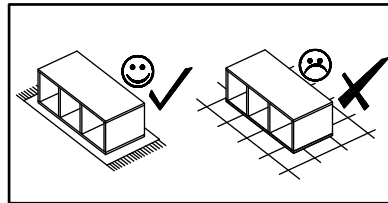
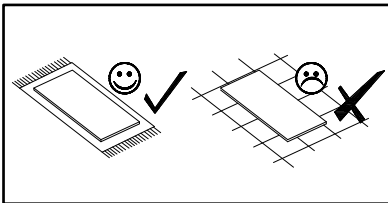
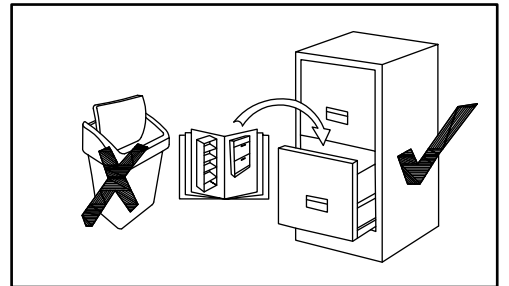
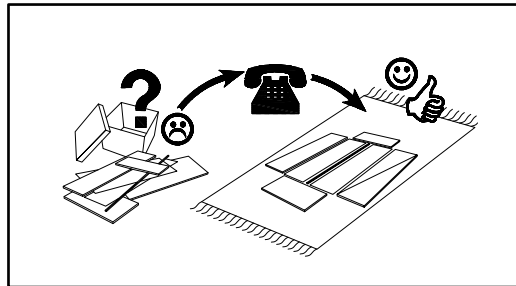
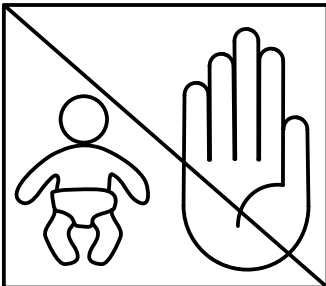
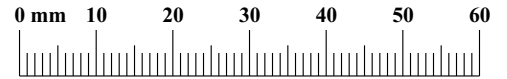

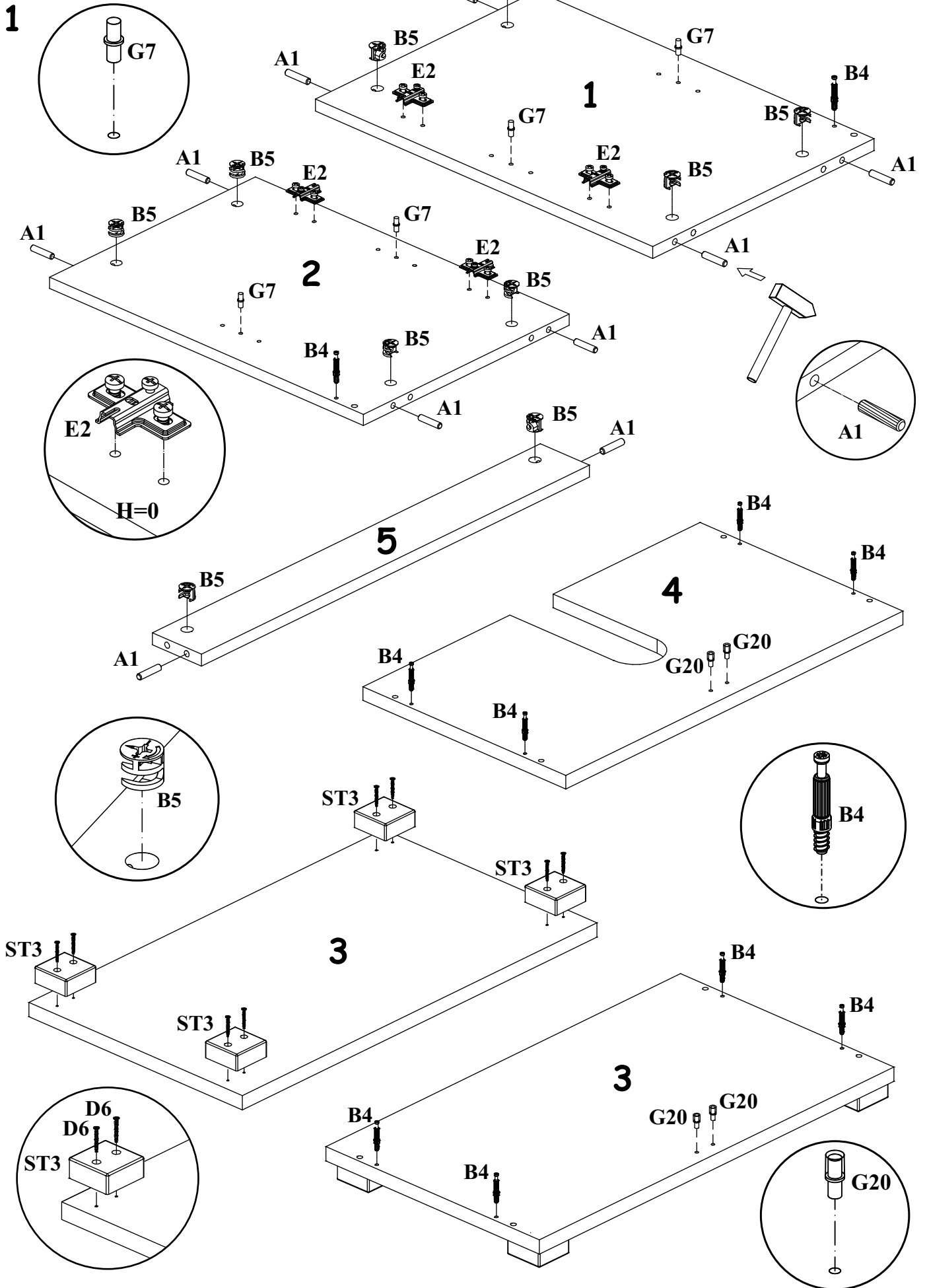

2

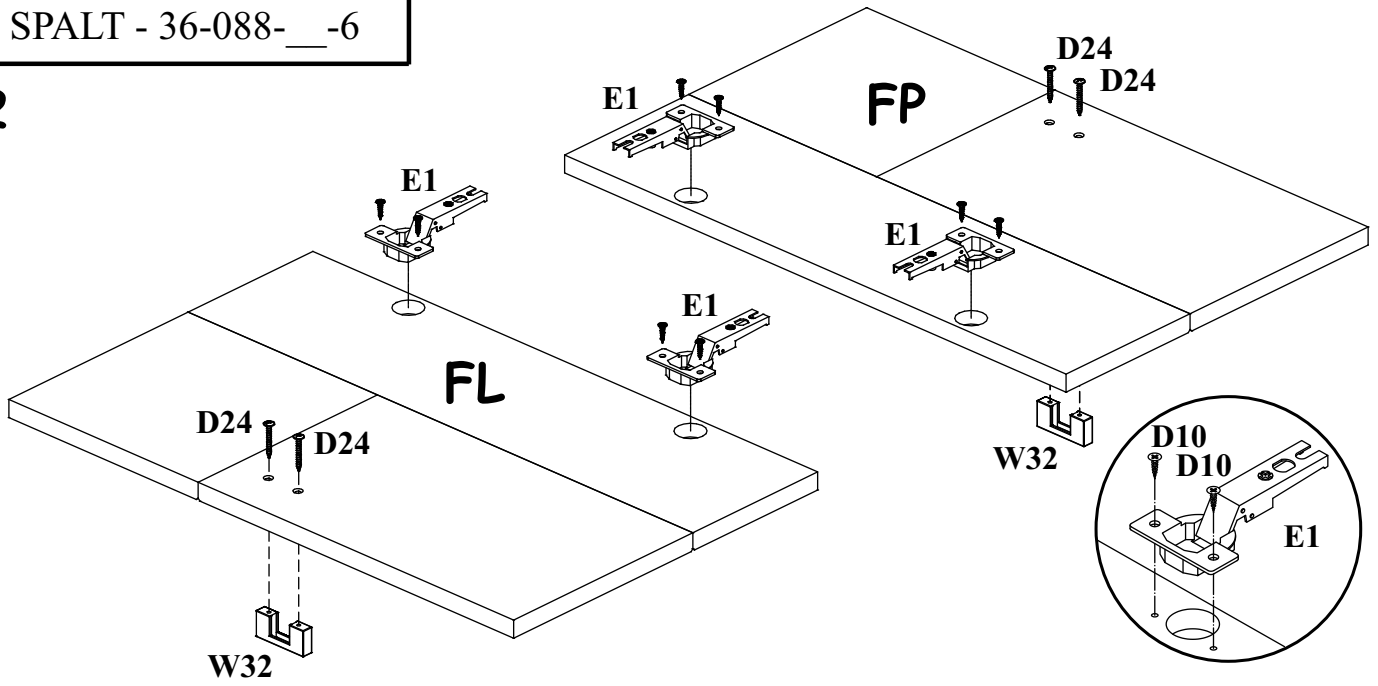

3

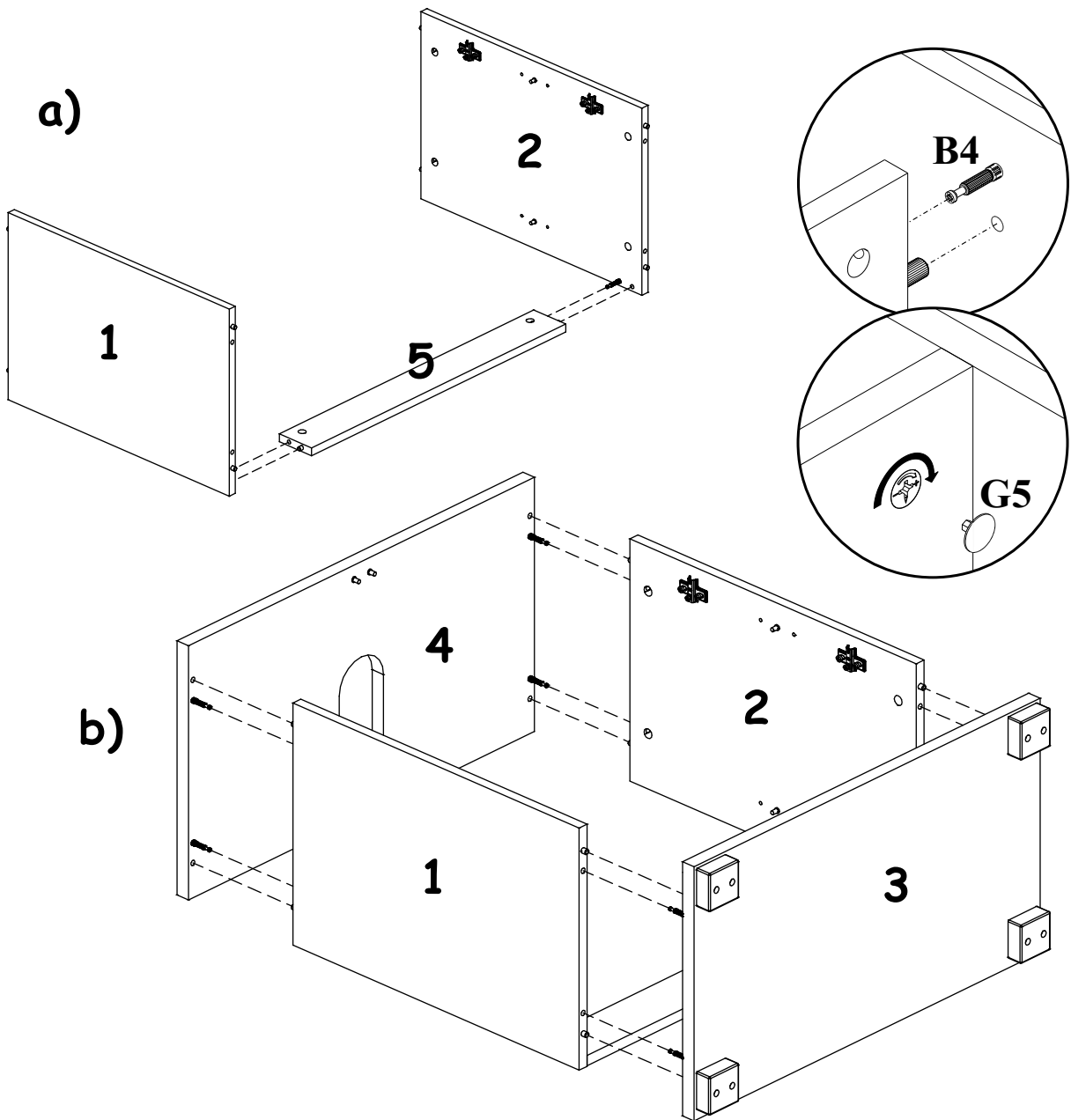

4

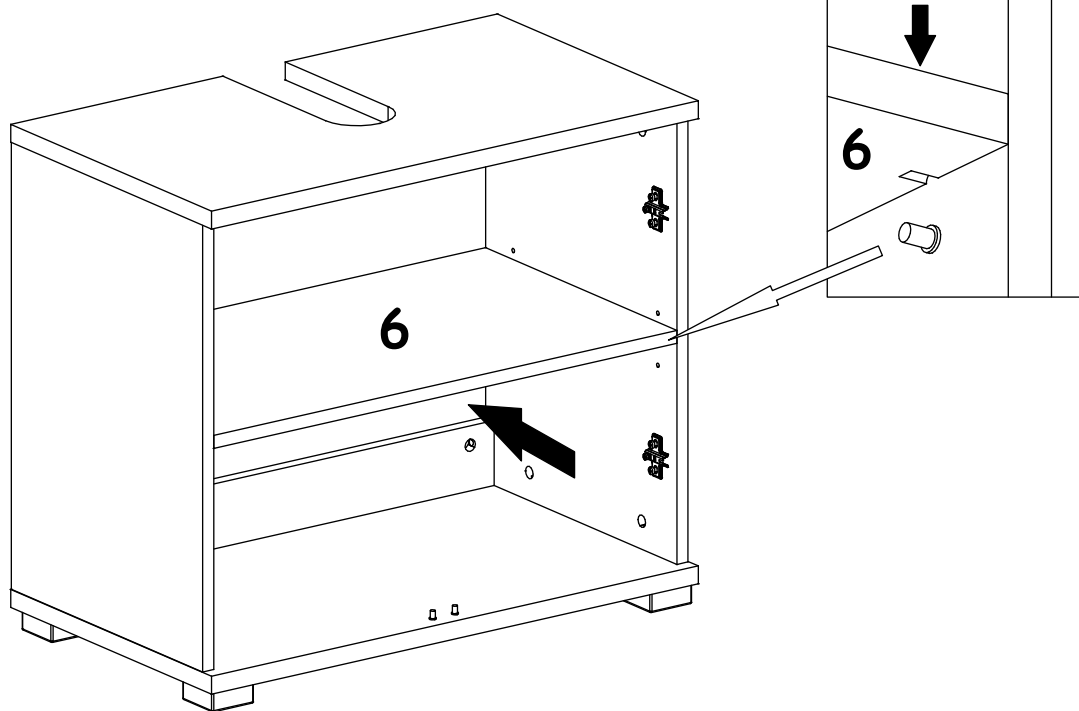

5

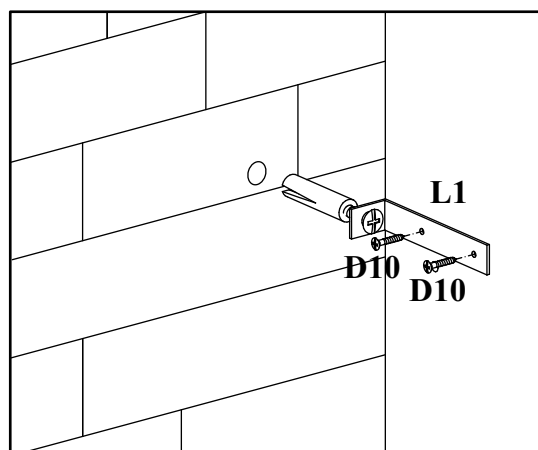
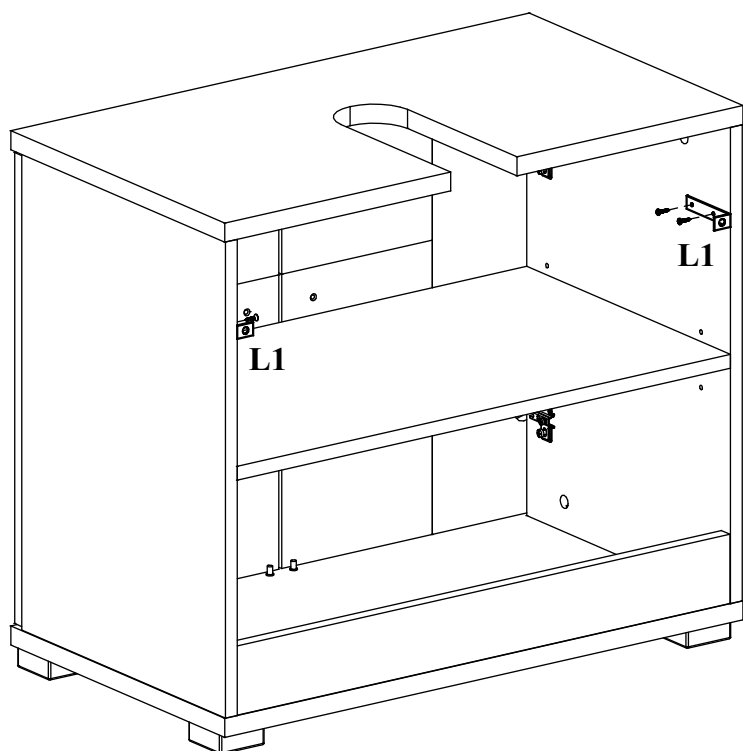
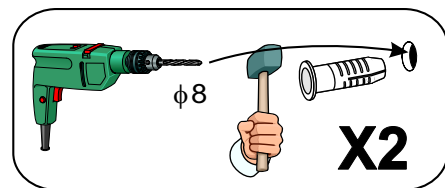
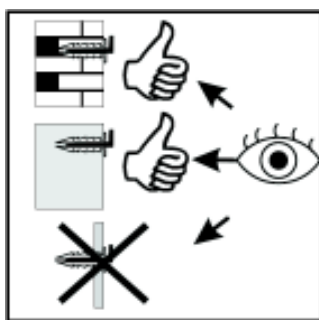

6

