

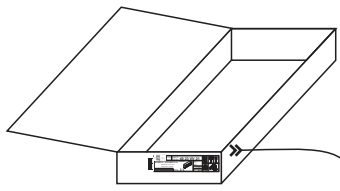

B - 400mm  
 H - 1840mm  
 T - 296mm

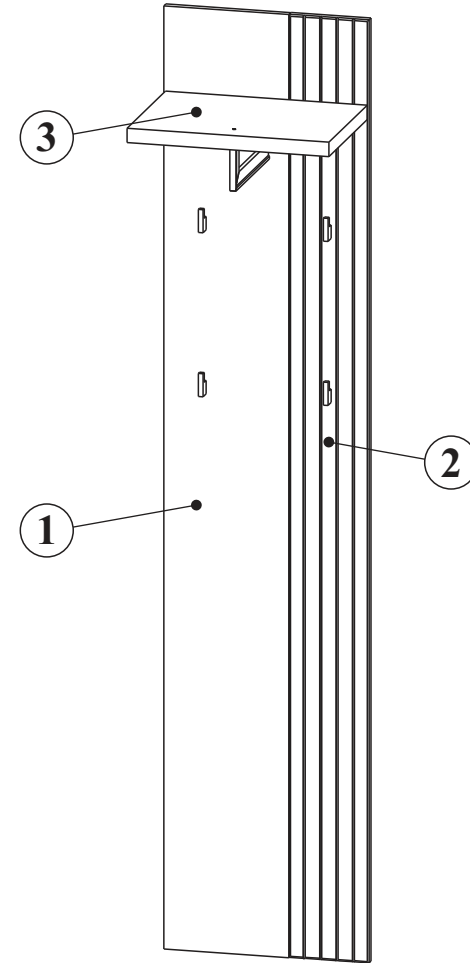

1	1840	244	1	1/1
2	1840	156	1	1/1
3,4	394	280	1	1/1

**NR 1**

**B20**   $\phi$  8x50 x4

**M1**   $\phi$  15x12mm x4

**T1**  5x39mm x4

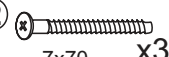
**K2**  7x70 x3

**C18**  5mm x2

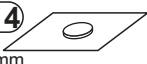
**C14**   $\phi$  20mm x1

**NR 2**

**F50**  x3

**E2**  6x8 x6

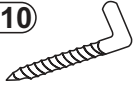
**T10**  x3

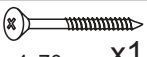
**S25**  4x70 x1

**T13**  8x50 mm x4

**NR 3**

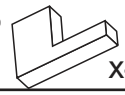
**U23**  x4

**A2**  M4x25 x9

**SZ21**  x1

**A10**  M4x40 x1



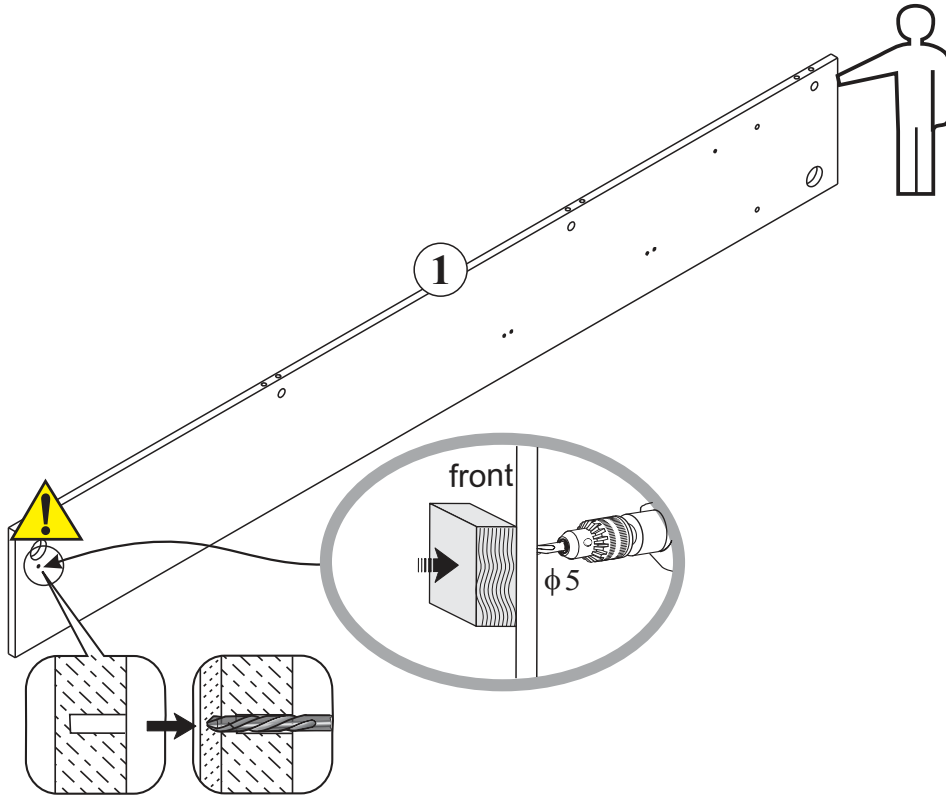
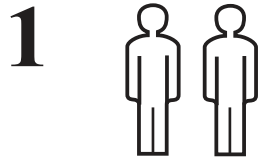

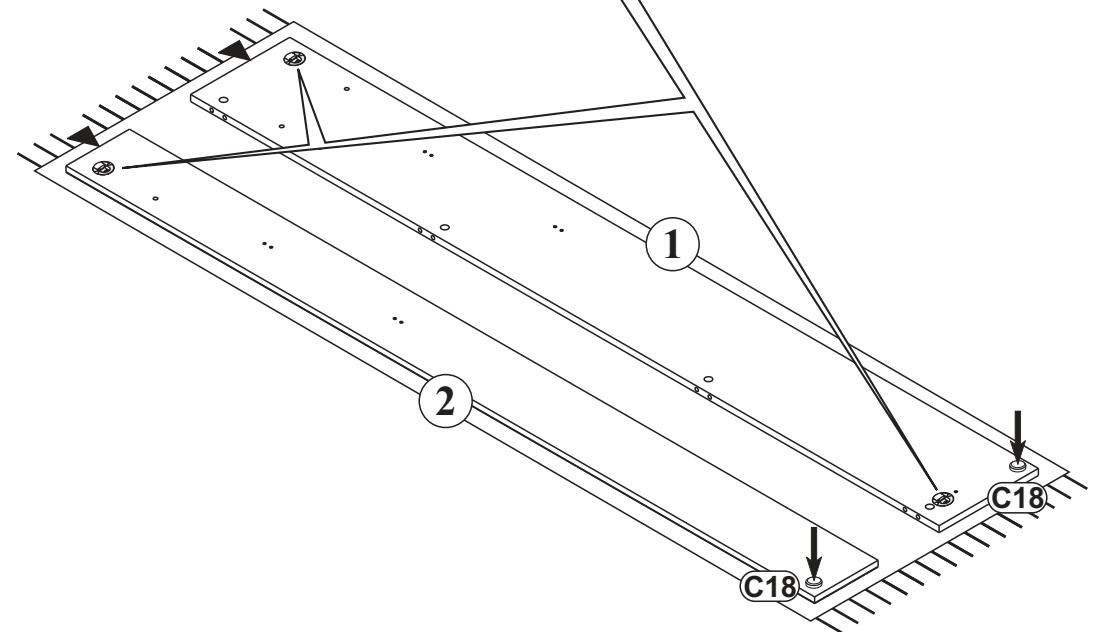
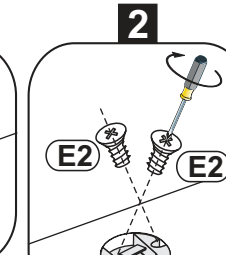
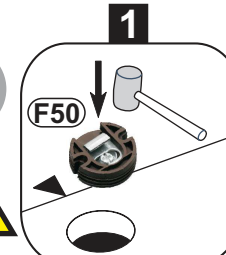
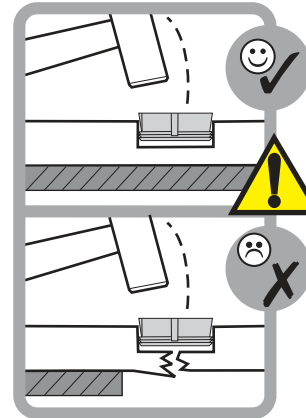
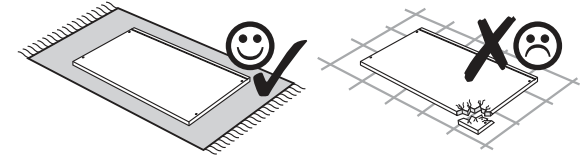
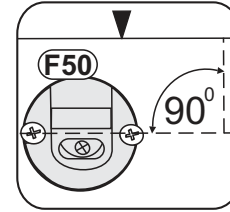
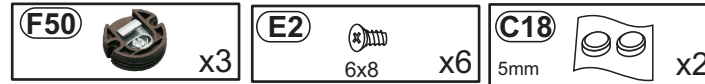

**2**



3

- B20**   $\phi$  8x50 x4
- M1**   $\phi$ 15x12mm x4
- T1**  5x39mm x4

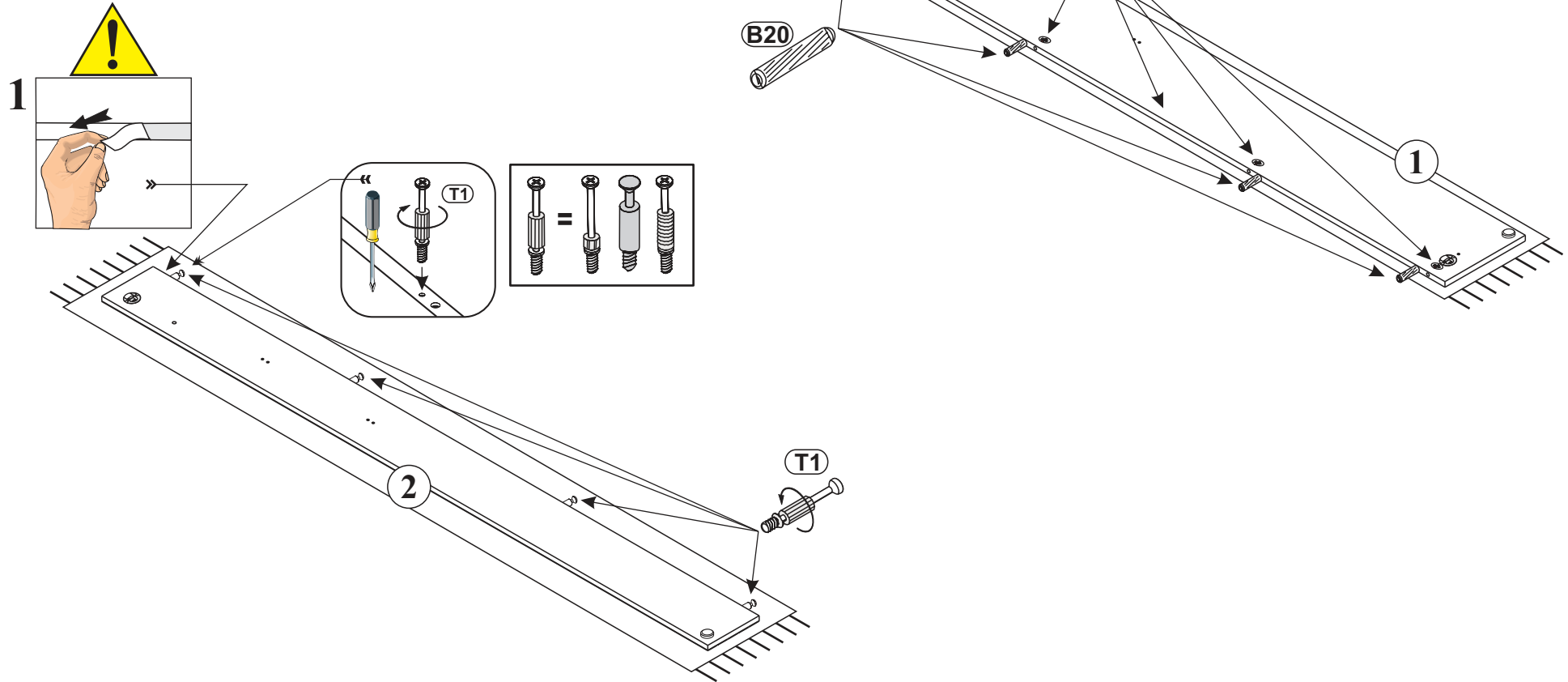

4

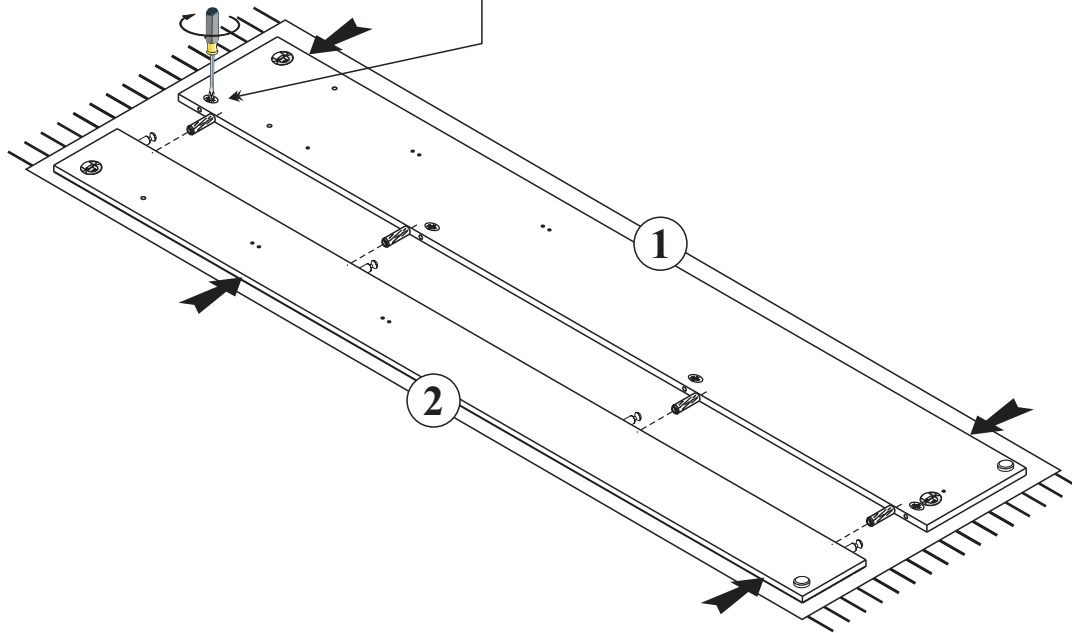
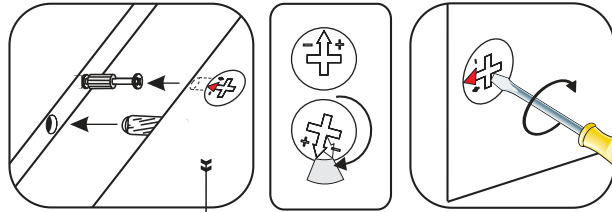

5

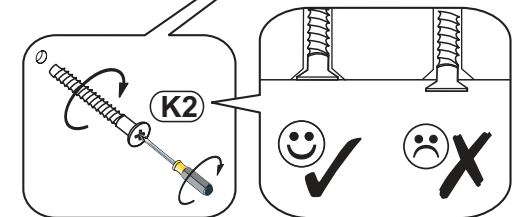
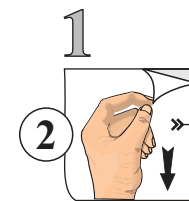
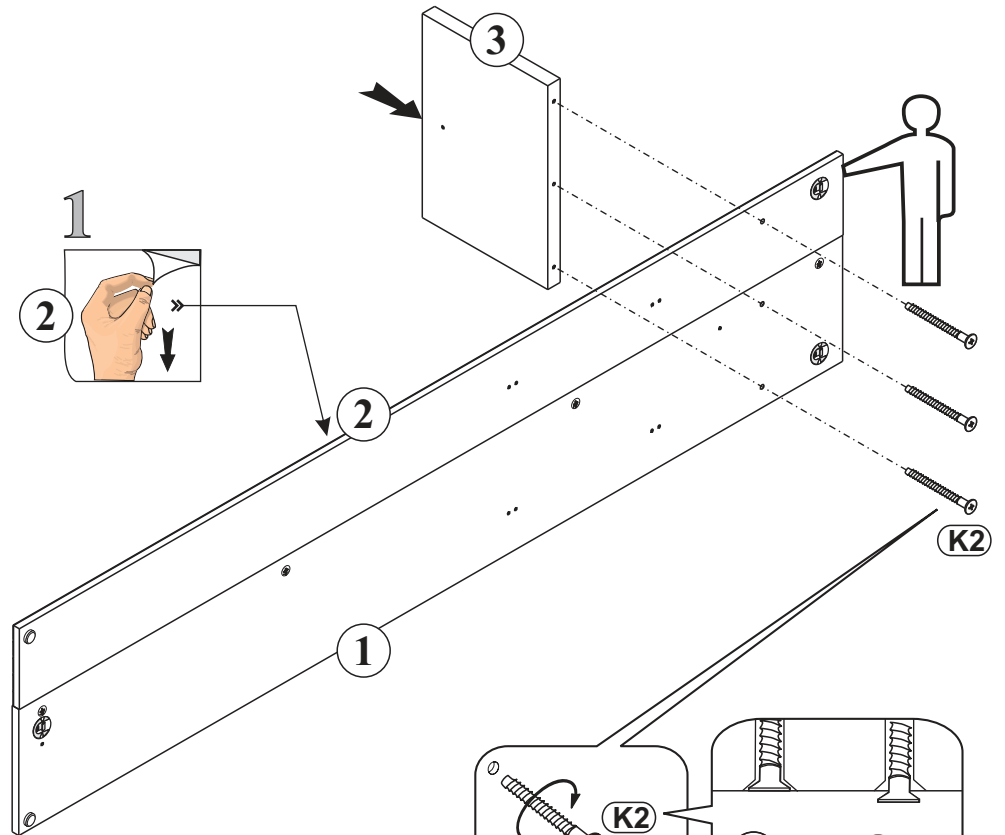
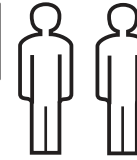
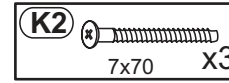

6

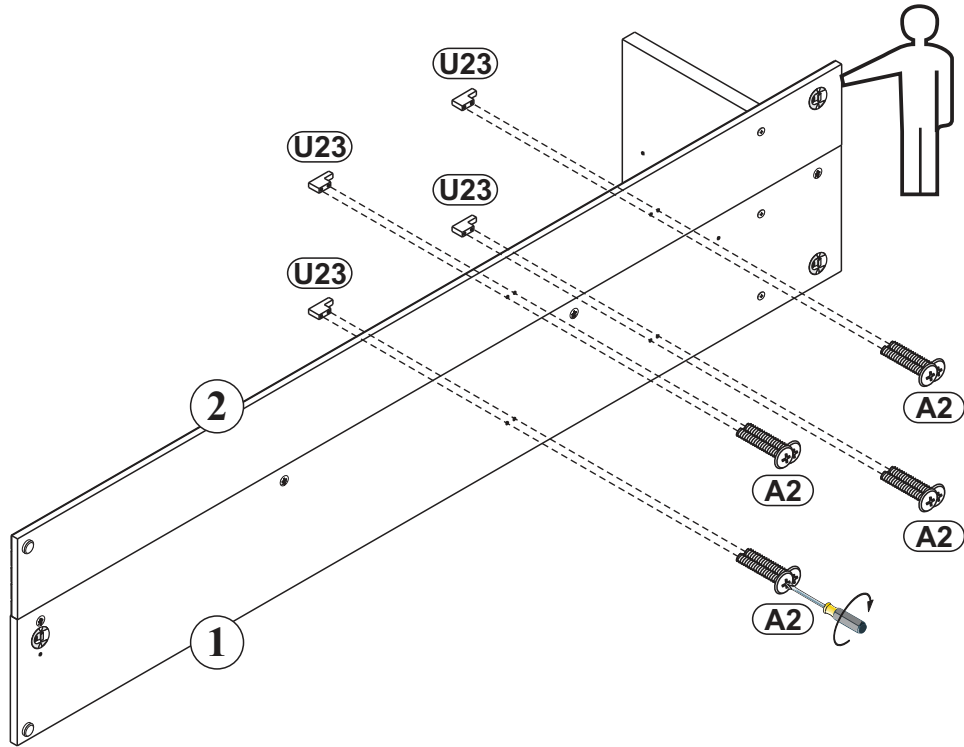
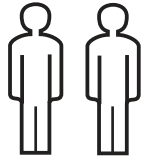
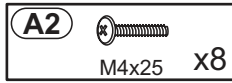
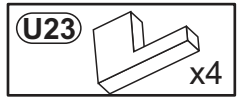

7

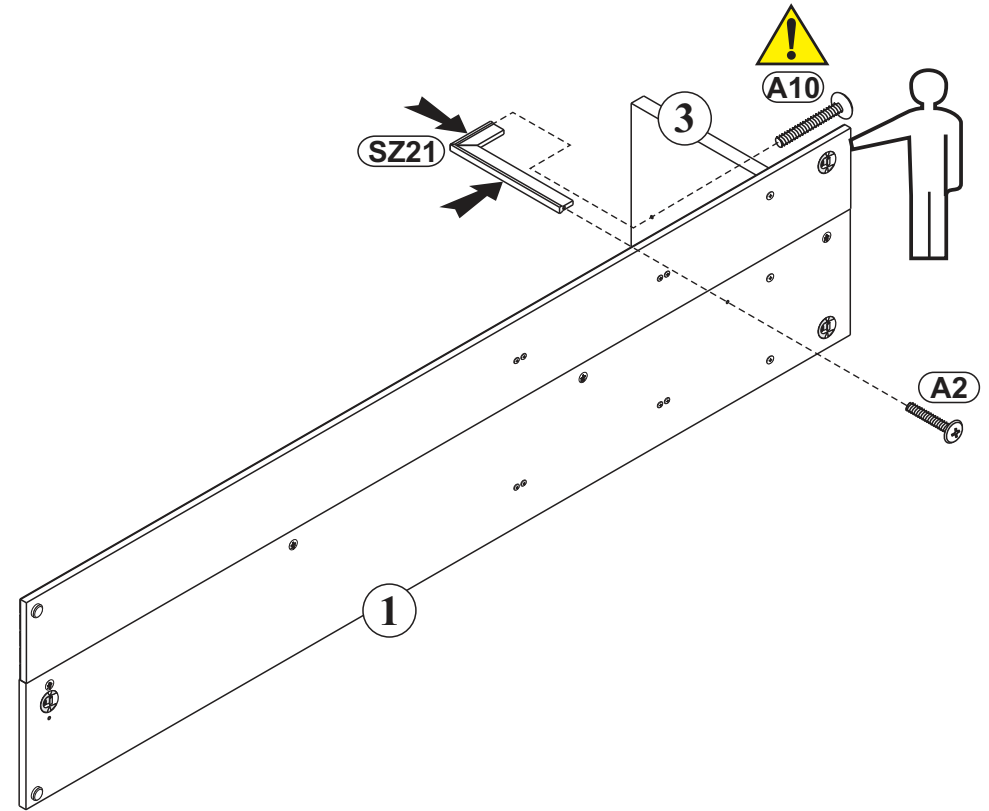
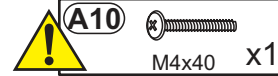
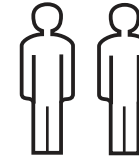
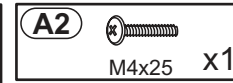
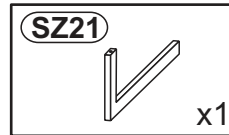

# 8

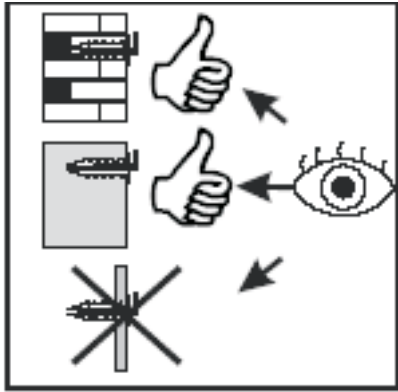

- T10** x3
- T13** 8x50 mm x4
- S25** 4x70 x1
- C14**  $\phi 20$ mm x1

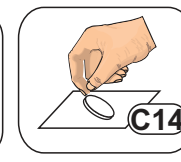
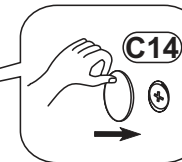
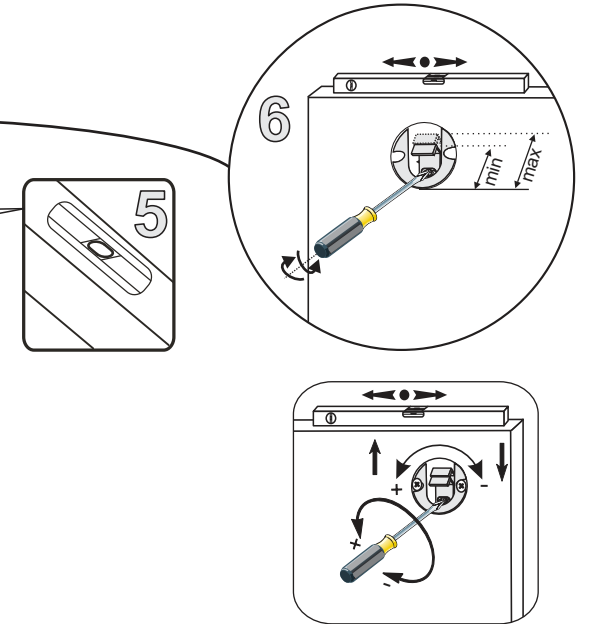
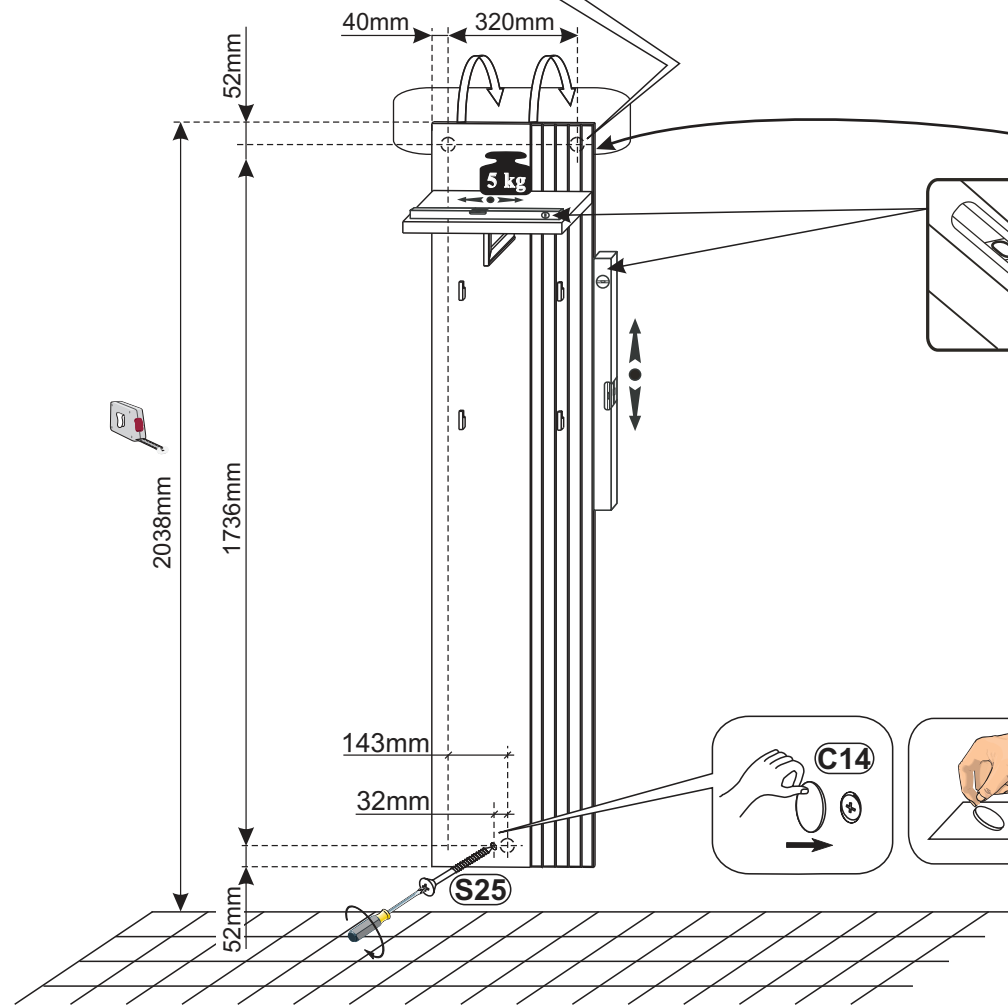
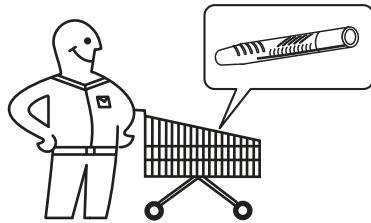
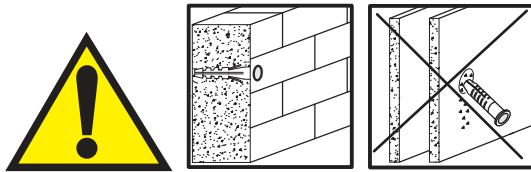
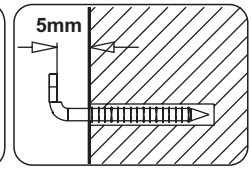
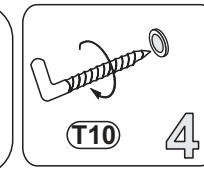
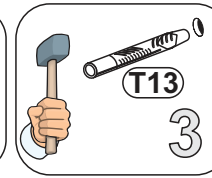
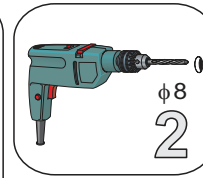
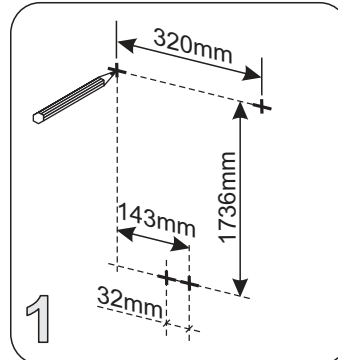



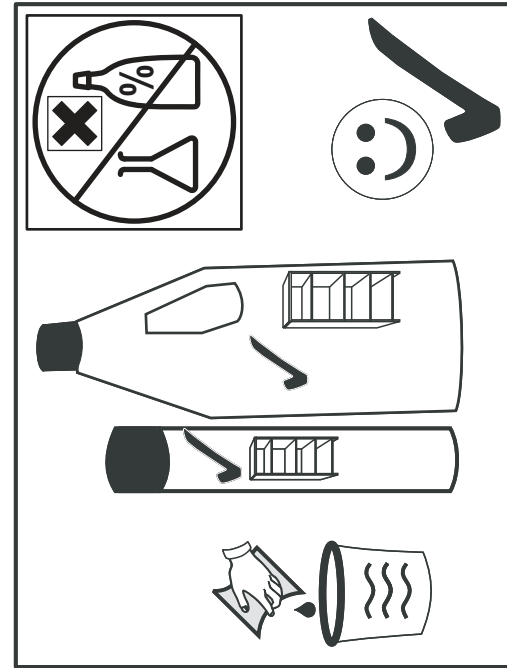
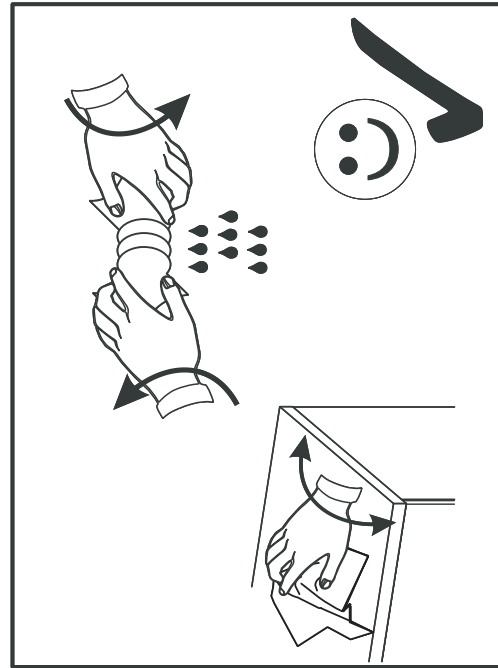
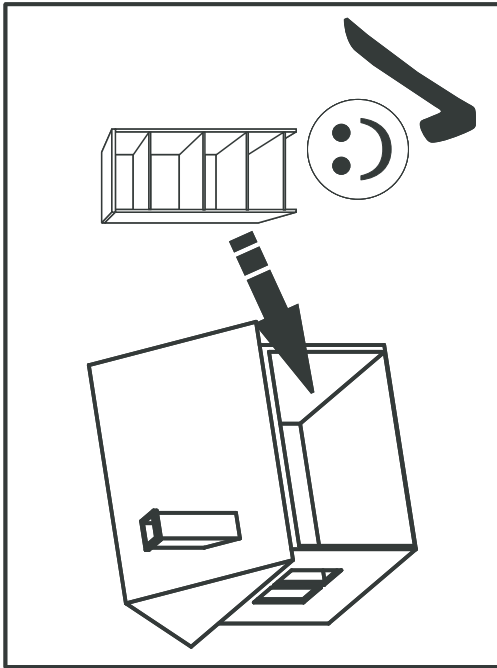
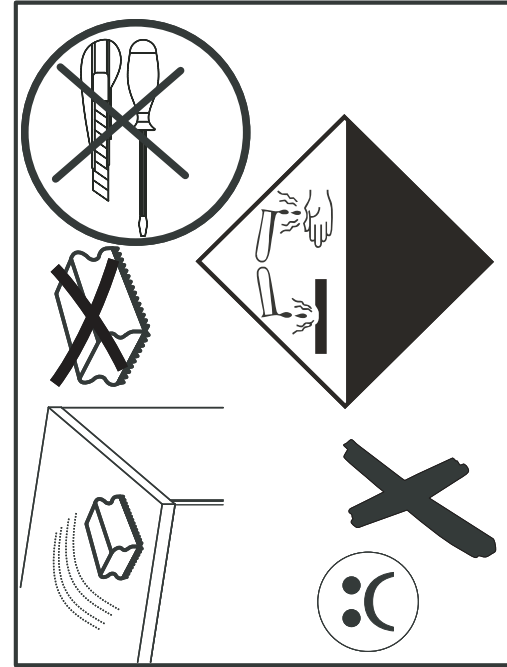
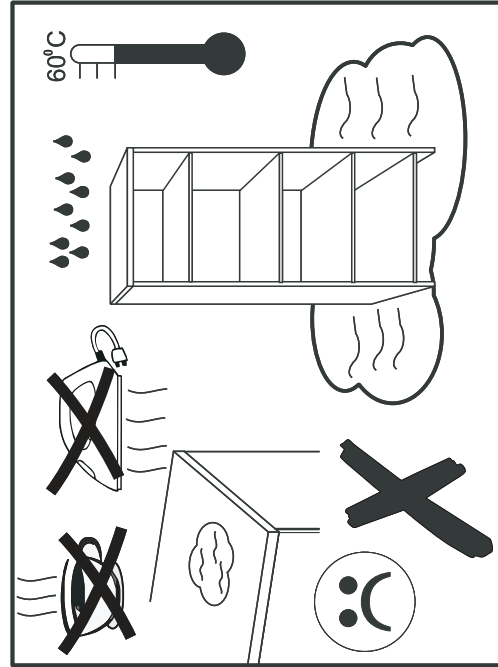
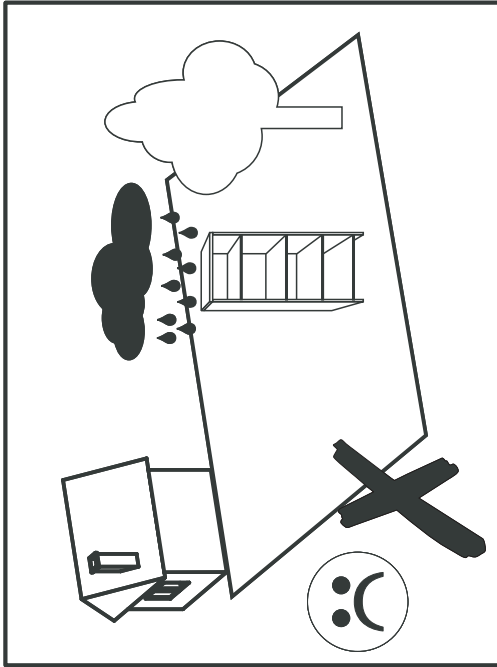
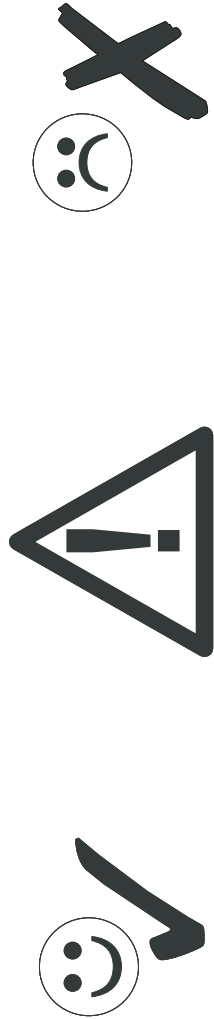

**D CH AT LI LU** Kleintelle und Verpackungsfolien bei der Möbelmontage von Kindern fernhalten!  
**GB US** Keep small parts and plastic film out of the reach of children!  
**FR BE NC** Tenir les petites pièces et les films plastiques hors de la portée des enfants!  
**NL** Hou de kleine onderdelen en de plastic folie uit de buurt van kinderen!  
**IT** Tenere i componenti di piccole dimensioni e le pellicole di plastica fuori dalla portata dei bambini!  
**SI** Malh delov in embalažne folije pri montaži pohištva hranite izven dosega otrok!  
**XS HR BA** Mahe dijelove i foliju za pakovanje priklom montaže namještaja držite dalje od djece  
**HU** Bútorészereket közbén a kis alkatrészek és a csomagoló fóliák gyermekéktől távol tartandók!  
**BG** Дребни детайли и опаковъчни фолиа да се държат далеч от деца при монтажа на мебелите!  
**CZ SK** Dřevní detaily i fólije za balení držte dále od dětí při montáži nábytku  
**SE** Vid möbelförpackning ska smådelar och förpackningsfolien hållas oåtkomliga för barn!  
**RO** Tineți departe de copii piesele mici și folia de ambalat la montarea mobiliei!  
**ES** ¡Durante el montaje, mantenga alejados de los niños las piezas pequeñas y el material plástico de embalaje!

**D CH AT LI LU** Möbelmontage muss auf ebennem Untergrund erfolgen. Bei Wandmontagen immer geeignetes Befestigungsmaterial verwenden.  
**GB US** Furniture must be assembled on a flat surface. For assembly to the wall only use suitable fixing materials.  
**FR BE NC** Le meuble doit être monté sur une surface plane. Pour le montage mural, utilisez des accessoires de fixation adaptés au type de mur.  
**NL** De meubels dienen op een vlakke ondergrond te worden gemonteerd. Voor wandmontage moeten geschikte bevestigingsmaterialen worden gebruikt.  
**IT** Il montaggio dei mobili deve avvenire su un fondo piano. Per il montaggio si prega di utilizzare solo materiali adatti.  
**SI** Pohištvo je treba montirati na ravni podlagi. Pri stenski montaži vedno uporabite pritrilivni material.  
**XS HR BA** Namještaj se mora montirati na ravnoj podlozi. Kod montaže na zid uvijek koristite prikladan materijal za pričvršćivanje.  
**HU** A bútor szerelését silk felületen kell végezni. Falra szereléshez mindig megfelelő rögzítanyagot kell használni.  
**BG** Монтажът на мебелите да се извършва на равна основа. При стенен монтаж винаги да се използва подходящ крепежен материал.  
**CZ SK** Montáž nábytku provádějte na rovném podkladu. Při montáži na stěnu používejte vždy vhodný příslušenství materiálu.  
**SE** Monterिंग av möbelen måste göras på jämnt underlag. Vid väggmontering ska lämpligt uppfästingsmaterial användas.  
**RO** Montarea mobiliei trebuie să se realizeze pe o pardoseală dreaptă. La montarea la perete utilizați întotdeauna material de fixare adecvat.  
**ES** El montaje debe efectuarse sobre una superficie uniforme. En el montaje mural emplee siempre el material de fijación adecuado.

**D CH AT LI LU** Bitte beachten Sie die Montageanleitung. Halten Sie immer die angegebene Wattzahl ein. Verhindern Sie einen Hitzezustand.  
**GB US** Please observe the assembly instructions. Do not exceed the max. given wattage. Ensure that the heat is not allowed to build up.  
**FR BE NC** Veuillez respecter la notice de montage. Respectez impérativement le nombre des watts maximal. Veillez à éviter toute accumulation de chaleur.  
**NL** Lees a.u.b. de montagehandleiding door. Hou de beslist aan het max. opgegeven wattage. Zorg ervoor dat geen hittehuizing ontstaat.  
**IT** Attenersi alle istruzioni di montaggio. Rispettarsi rigorosamente il numero di watt max. indicato. Assicurarsi che non si verifichi un accumolo di calore.  
**SI** Upoštevajte navodila za montažo. Vedno upoštevajte navedeno število vatov. Preprečite zastoj vročine.  
**XS HR BA** Obratite pažnju! Vas pozor na uputu za montažu. Uvijek se pridržavajte navedenog broja vat. Izbjegavajte zastoj vrućine.  
**HU** Vegye figyelembe a szerelési útmutatót. Mindig tartsa be a megadott wattszámot. Akadályozza meg a hőelődést.  
**BG** Моля, вземете под внимание ръководството за монтаж. Спазвайте винаги посочените ватове. Избягвайте акумулиране на топлина.  
**CZ SK** Dodržujte prosím návod k montáži. Vždy dodržujte uvedenou hodnotu výkonu (watt). Zabráňte tak přehřívání.  
**SE** Följ monteringsanvisningen. Följ alltid angivet watttal. Undvik att hetta uppstår.  
**RO** Respectați instrucțiunile de montaj. Respectați întotdeauna numărul de watt impus. Evitați acumularea de căldură.  
**ES** Le rogamos que tenga presente las instrucciones de montaje. Respete siempre el número indicado de vatios. Evite la acumulación de calor.

**D CH AT LI LU** Halten Sie die max. zulässigen Belastungswerte der Möbelteile ein. Details siehe Montageanleitung  
**GB US** Comply with the max. permissible loads. For details, please refer to the assembly instructions  
**FR BE NC** Respectez les valeurs de charge max. admissibles des parties de meubles. Pour plus de détails, cf. la notice de  
**NL** Hou de maximaal geoorloofde belastingswaarden van de meubeldelen aan. Voor details verwijzen wij naar de montagehandleiding  
**IT** Rispettare la portata max. permessa degli elementi del mobile. Per dettagli si vedano le istruzioni di montaggio e si vada  
**SI** Upoštevajte največjo dovoljeno obremenitev delov pohištva. Podrobnosti najdete v navodilih za montažo in na  
**XS HR BA** Tarta da ve a bitorelemek max. dopuštjenih vrijednosti elemenata namještaja. Detalje vidj u uputu za montažu  
**HU** Tartsa be a bitorelemek max. megengedett terhelési értékeit. A részleteket lásd a szerelési útmutatóban  
**BG** Спазвайте макс. допустимите стойности на натоварване на мебелите. За подробности виж ръководството за монтаж  
**CZ SK** Dodržujte max. přípustné hodnoty zatížení nábytkových dílů. Podrobnosti viz návod k montáži  
**SE** Följ max. tillåten belastning av möbeldelarna. Mer information finns i monteringsanvisningen  
**RO** Respectați valorile de solicitare max. admise pentru corpurile de mobilier. Pentru detalii consultați instrucțiunile de montaj  
**ES** Respete los valores máximos de carga admisibles para las piezas de los muebles. Consulte los detalles en las instrucciones

**D CH AT LI LU** Zur Möbelfreinigung ein mit Wasser befeuchtetes, fusselfreies Baumwolltuch verwenden. Geeignigte Flächen immer trockenreiben!  
**GB US** To clean the furniture only use a water dampened lint-free cotton cloth. Once cleaned, always wipe the surfaces dry.  
**FR BE NC** Utilisez un chiffon en coton non pelucheux humidifié avec de l'eau pour nettoyer les meubles. Séchez systématiquement les surfaces  
**NL** nettooyes en les froltant!  
**IT** Gebruik een met water bevochtigde, pluusvrije katoenen doek om de meubels te reinigen. Wrijf gereinigde oppervlakken altijd droog!  
**SI** Per pulire il mobile utilizzare un panno di cotone inumidito d'acqua e che non perde pelucchi. Asciugare sempre le superfici che si sono pulite!  
**XS HR BA** Za čišćenje pohištva uporabljajte vlažno bombažno krpo, ki ne pušča vlaken. Očiščene površine vedno obrišite do suhlega!  
**HU** Za čiščenje namještaja koristite sa vodom navlaženu pamučnu krpu koja ne ispušta vlakna. Očišćene površine uvijek obrišite suhom krpom!  
**BG** За почистване на мебелите използвайте навлажнена с вода, неизглусяща влакна памучна кърпа. Почистените повърхности винаги да се изтриват до сухо!  
**CZ SK** K čištění nábytku používejte bavlněný hadr neuvloňující vlákna, navlhčený ve vodě. Učištěné plochy vždy utřete do sucha!  
**SE** För möbelförpackning används en luddfri bomullsduk fuktad med vatten. Rengjorda ytor ska alltid torflas torra!  
**RO** Pentru curățarea mobiliei utilizați o lavetă din bumbac fără scame umezită cu apă. Suprafețele curățate se șterg întotdeauna până se usucă!  
**ES** Emplee un paño de algodón humedecido con agua y libre de pelusa para la limpieza de los muebles. ¡Seque siempre las superficies que ha limpiado!