

MONTAGEANLEITUNG

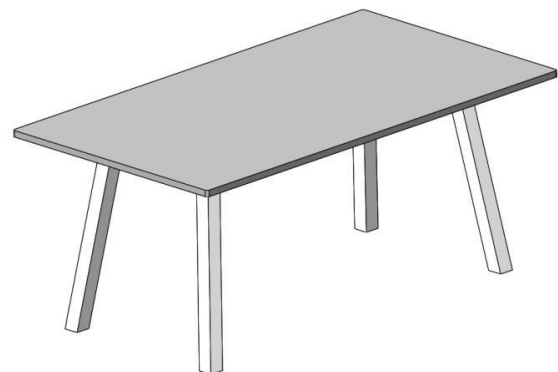

ASSEMBLY INSTRUCTION

NOTICE DE MONTAGE

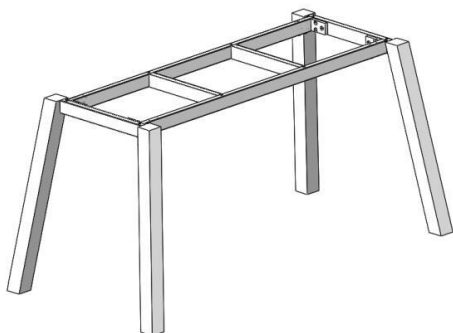
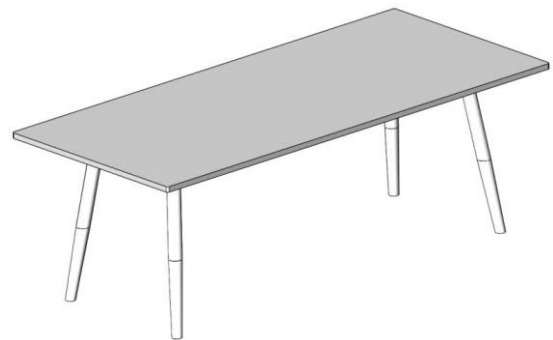
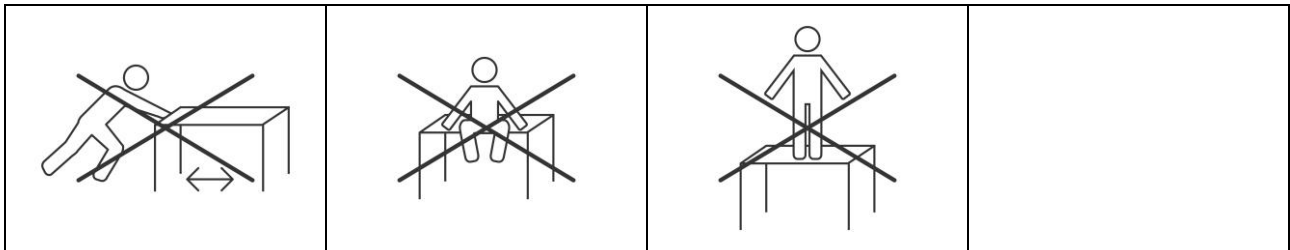
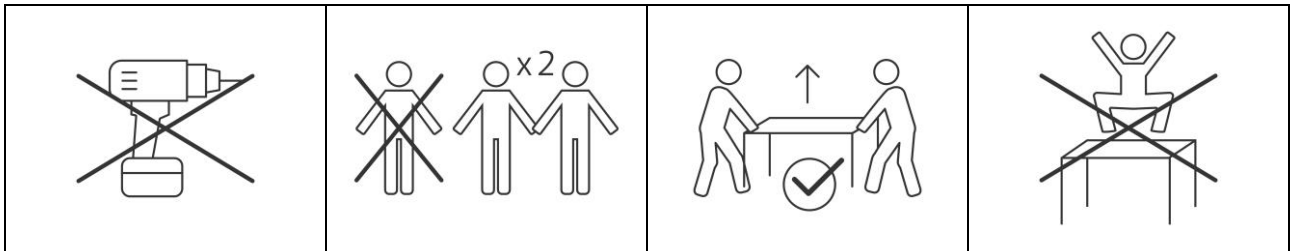

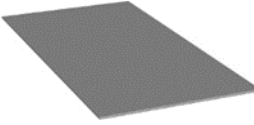

Dieser Montageschritt gilt nur für Teak-Tischplatten /// This assembly step only applies for Teak table tops /// Cette étape de montage ne s'applique qu'aux plateaux de table Teck

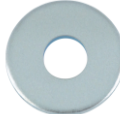
E 1 x	F 8 x M5 x 60	G 8 x Ø 5,3 mm	
			

1.

Benötigte Werkzeuge / Required tools / Outils nécessaires

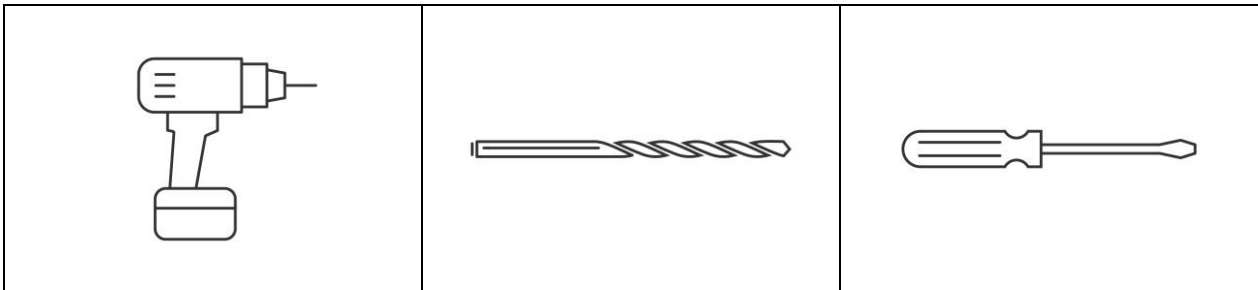

Holzbohrer Ø 3mm
Wood drill Ø 3mm
Perçage du bois Ø 3mm

2.

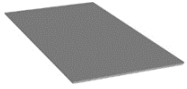

E | 1x

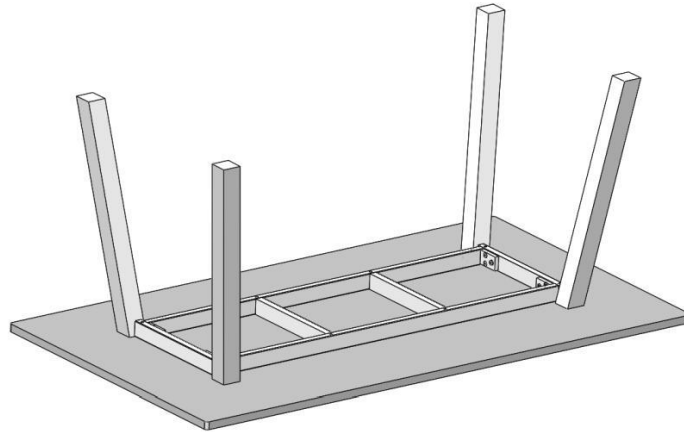

Tischplatte ausrichten / Align table top / Aligner le plateau de table



3.

	Ø 3mm				
					

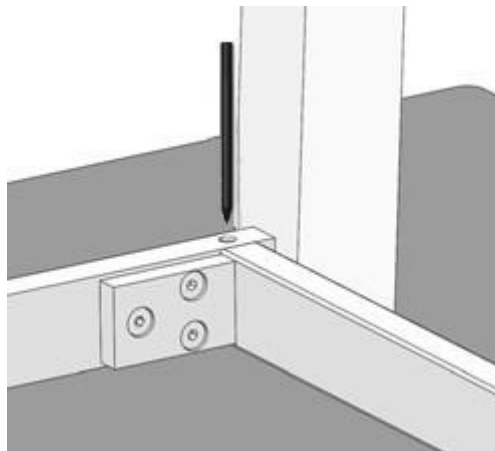

Bohrloch erst markieren und dann max. 5mm tief bohren
 Mark drill hole first and then drill max. 5mm deep
 Marquer d'abord le trou de perçage, puis percer à une profondeur maximale de 5mm



4.

F | 8x

G | 8x

