

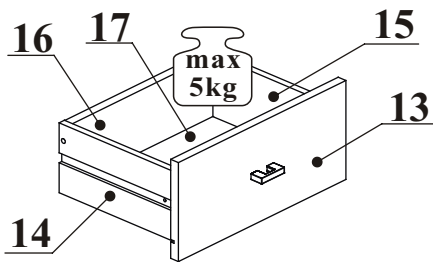

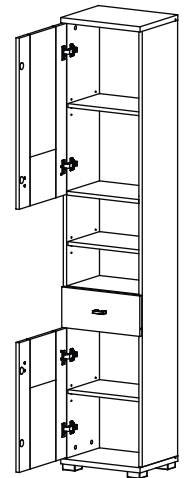

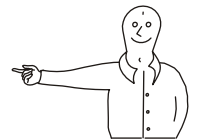

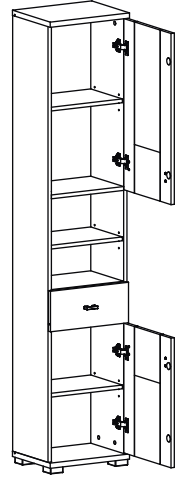

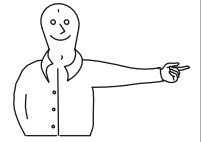
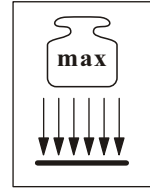
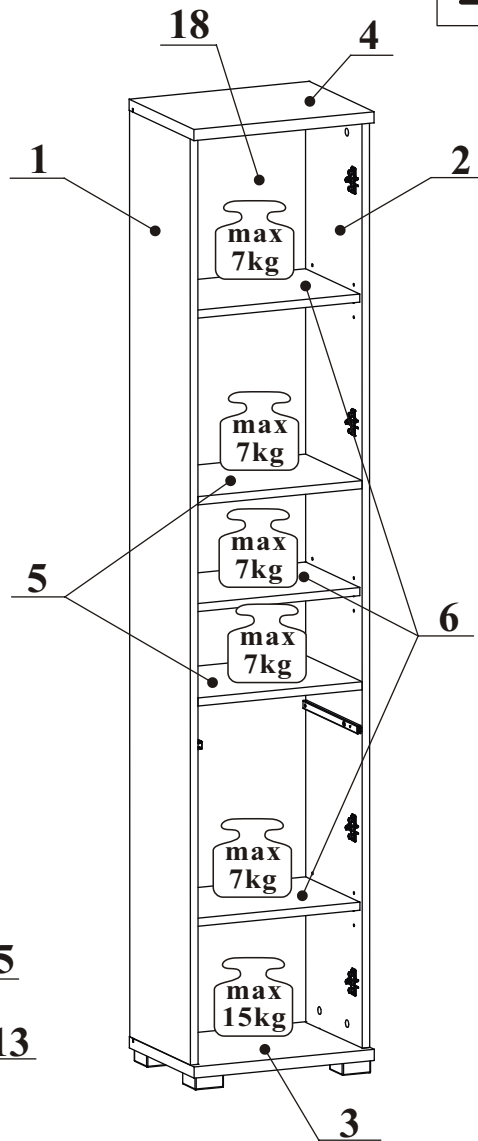
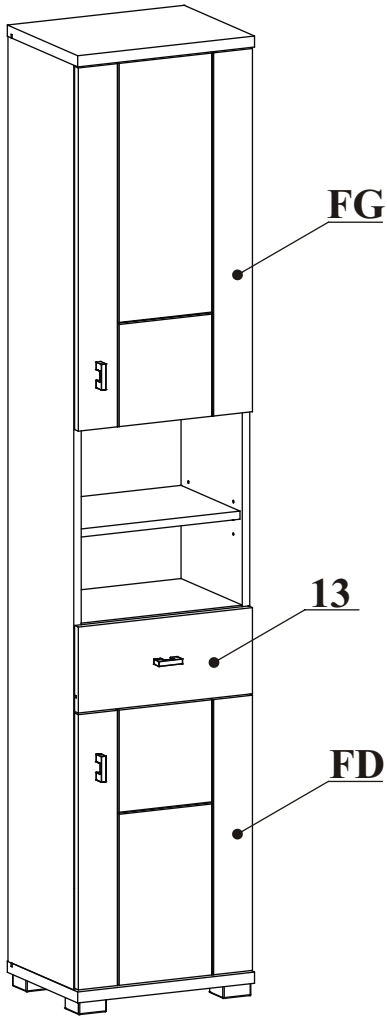
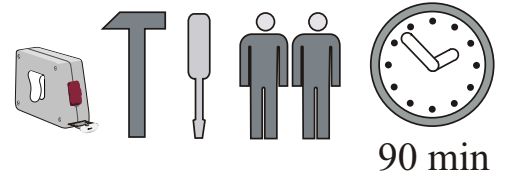
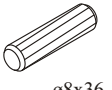
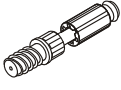



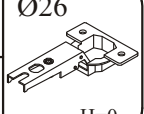
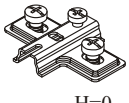

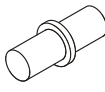



# SPALT 70-088-\_\_-6

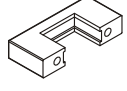

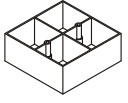
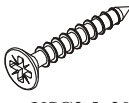
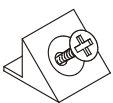
NO	Dim.		Col.-No	Qty
1	1828	281	1	1
2	1828	281	1	1
3	382	300	1	1
4	382	300	1	1
5	348	261	1	2
6	348	251	1	3
FD	376	544	1	1
FG	376	718	1	1
13	376	170	1	1
14	250	120	1	1
15	250	120	1	1
16	315	106	1	1
17	325	254	1	1
18	1840	360	1	1

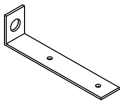
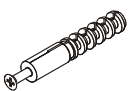
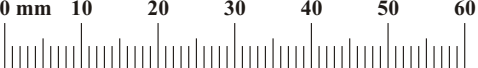

A1 X20  ø8x36	B4 X18 	B5 X16  ø15x12	G5 X16 	B7 X2  Ø15x10,3	G8 X2  Ø20
E1 X4  H=0	E2 X4  H=0	D10 X10  USØ3,5x13	G7 X12 	B11 X2  Ø7x50	G4 X2 
H6 X1  L-250mm.	D18 X2  M4x9	D20 X4  ESØ6x9,5	UP13 X9  UPØ3x16	W32 X3  L-32mm.	UP6 X6  UPØ4x30
ST3 X4  60x60x25	D6 X8  USØ3,5x30	S1 X15 	G2 X1 	Z2 X12  Ø5	G1 X4  Ø26
L1 X1 	KR1 X1 				

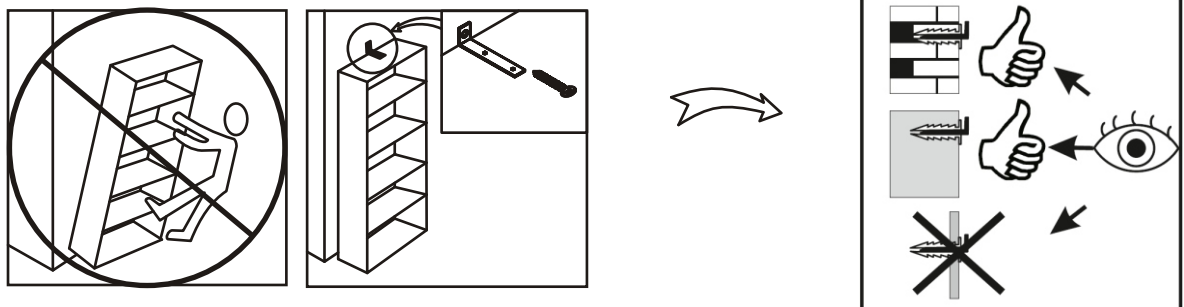
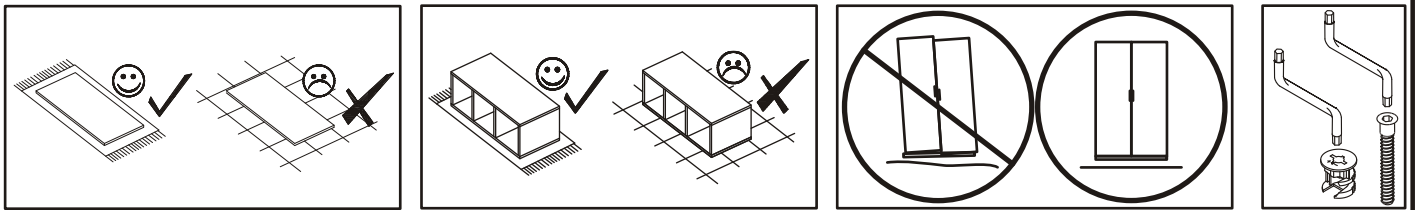
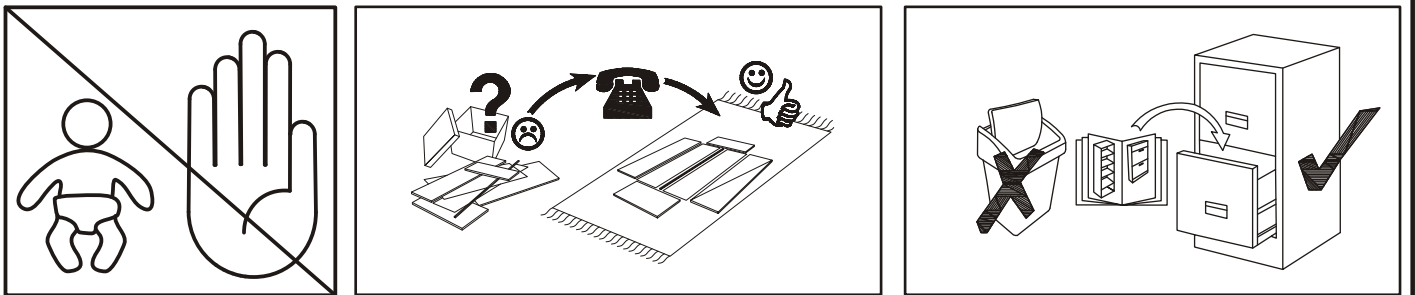

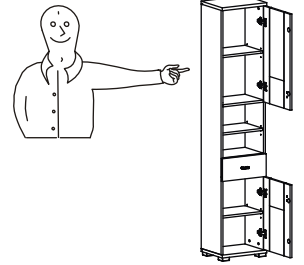

**1**

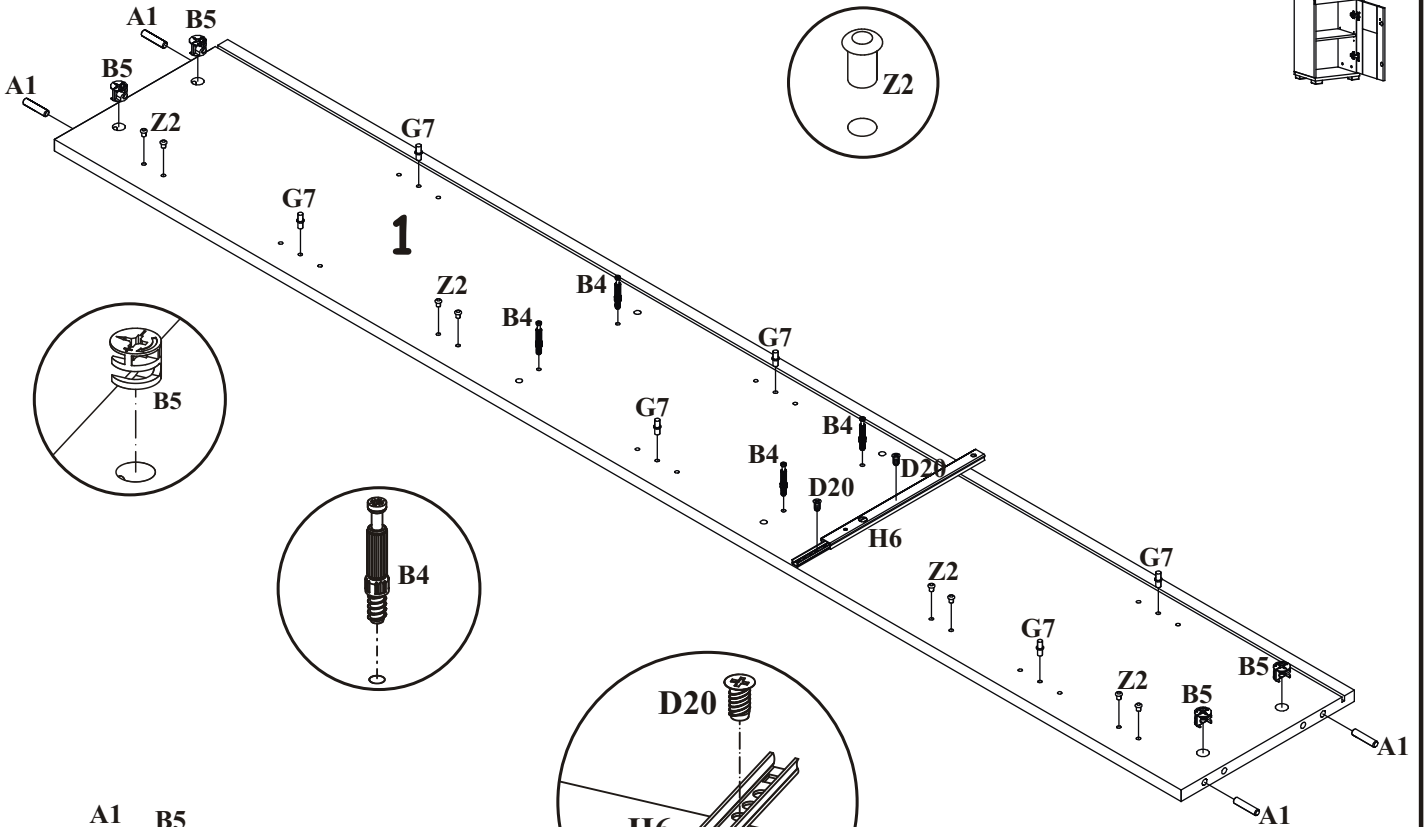

**1**

**2**

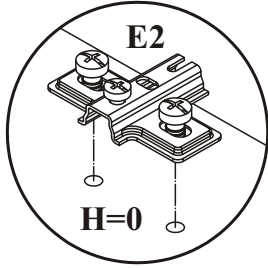
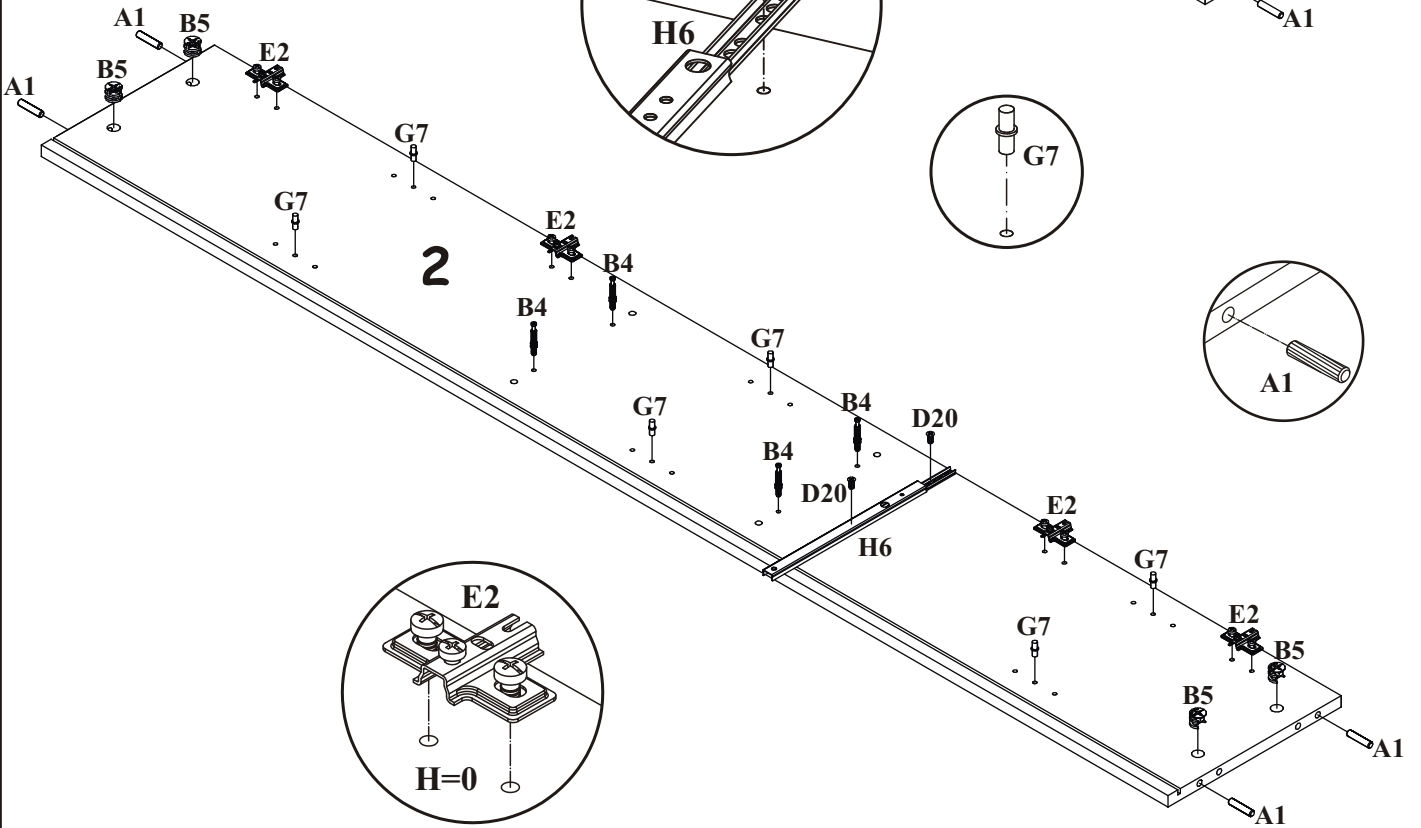

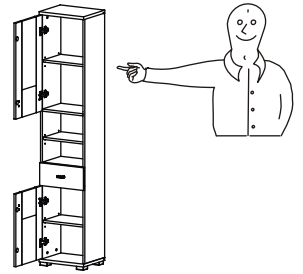

2

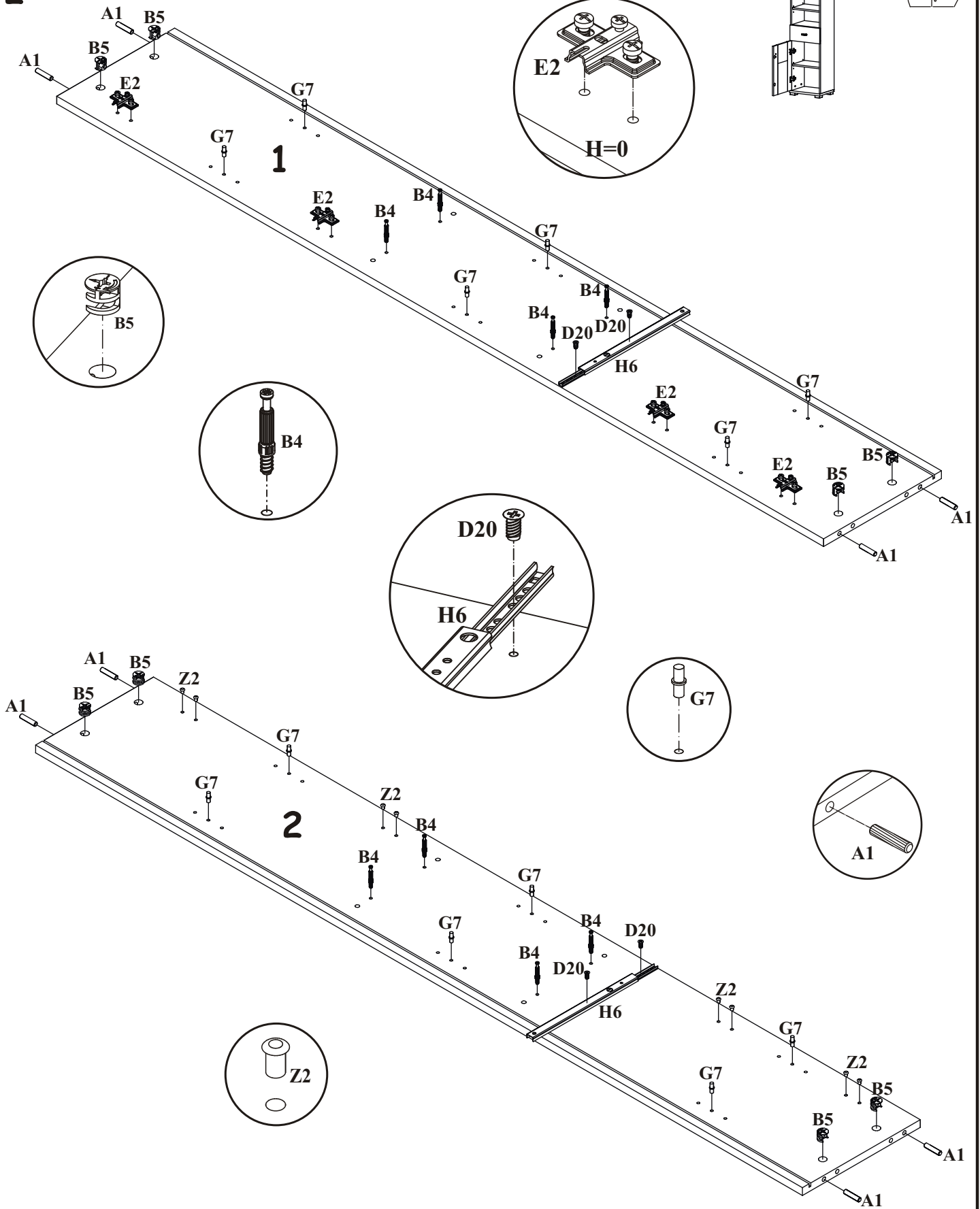

3

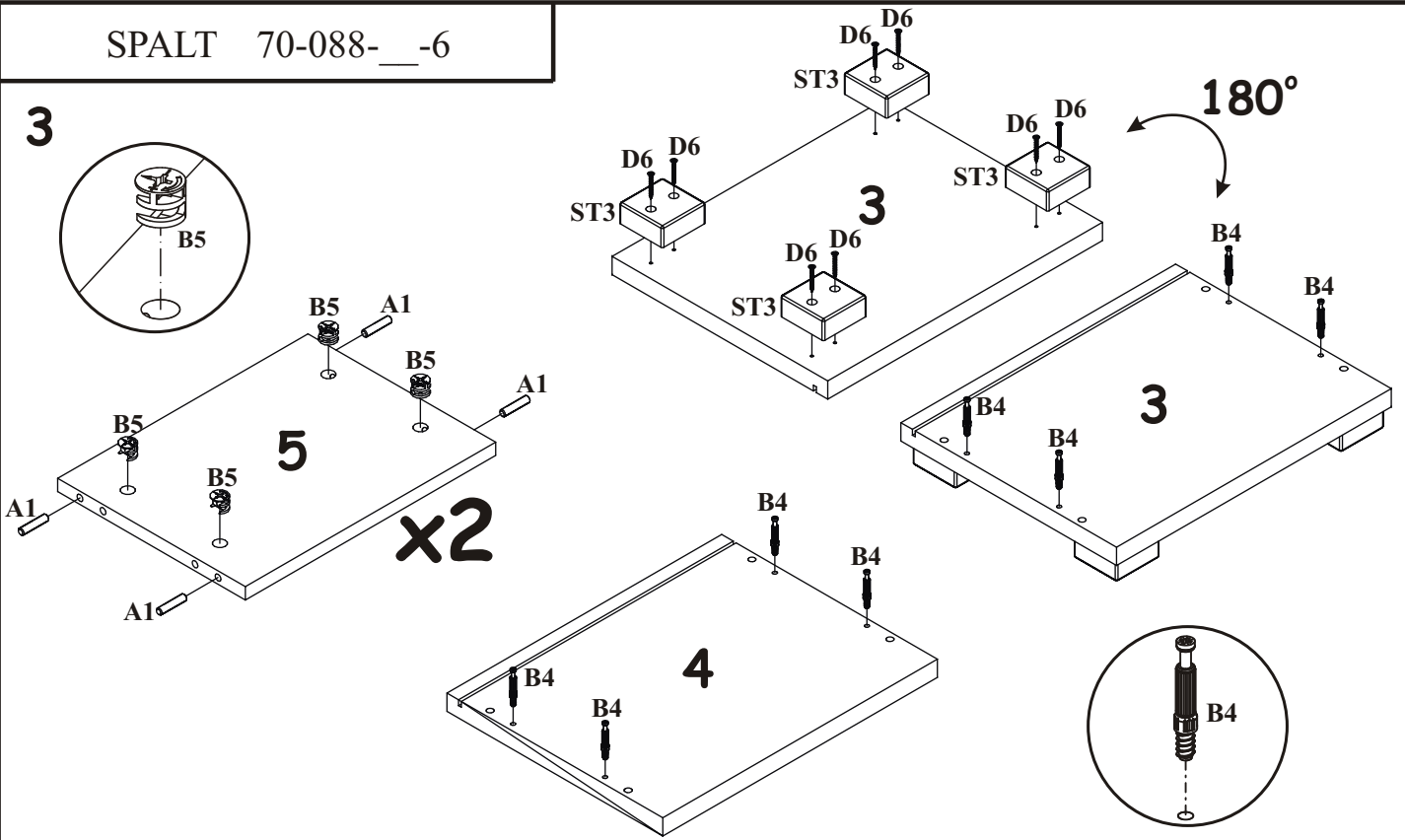

4

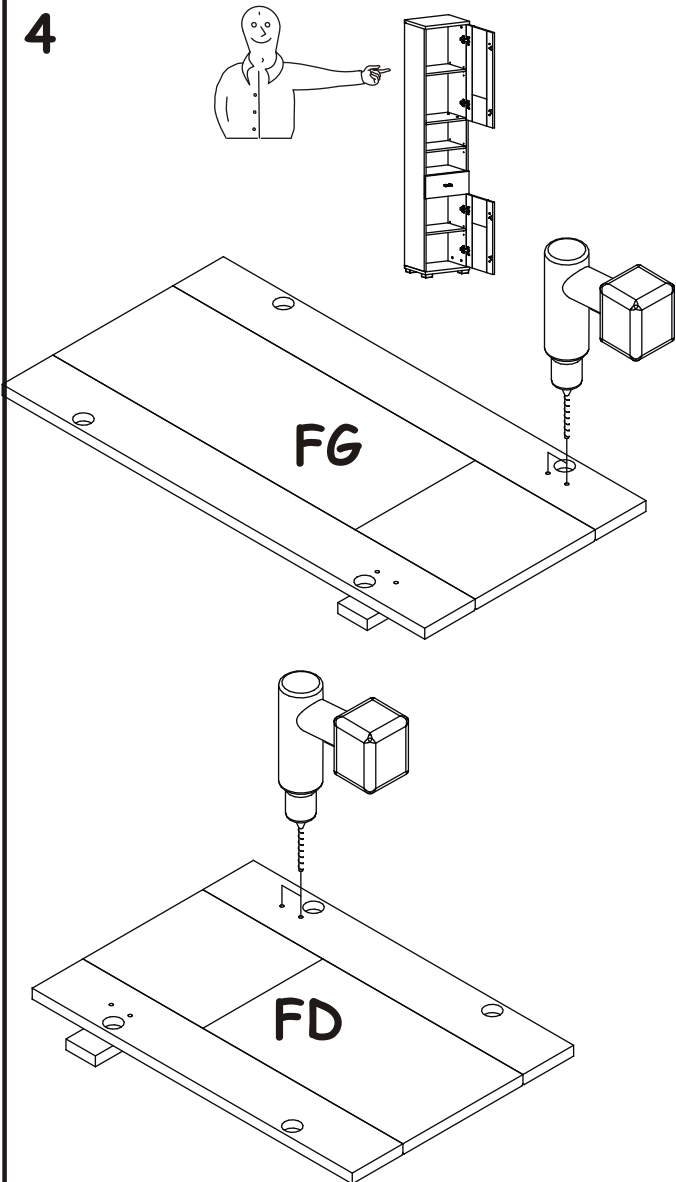

4

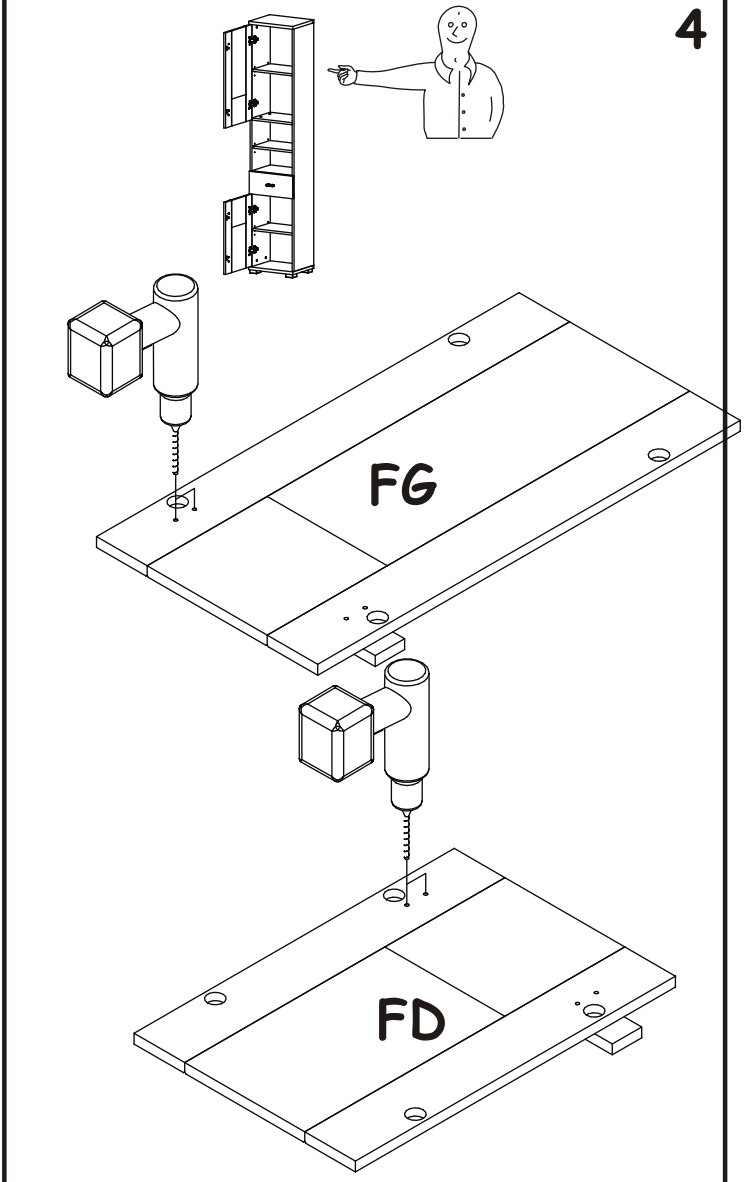

5

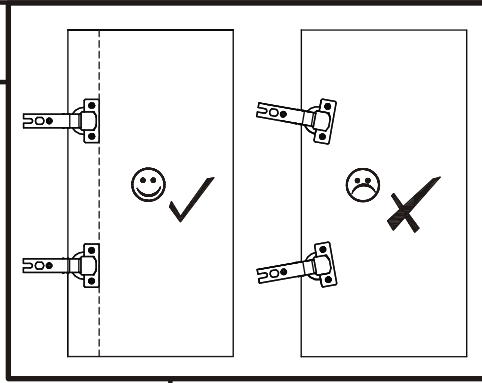
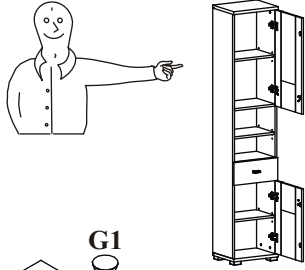

5

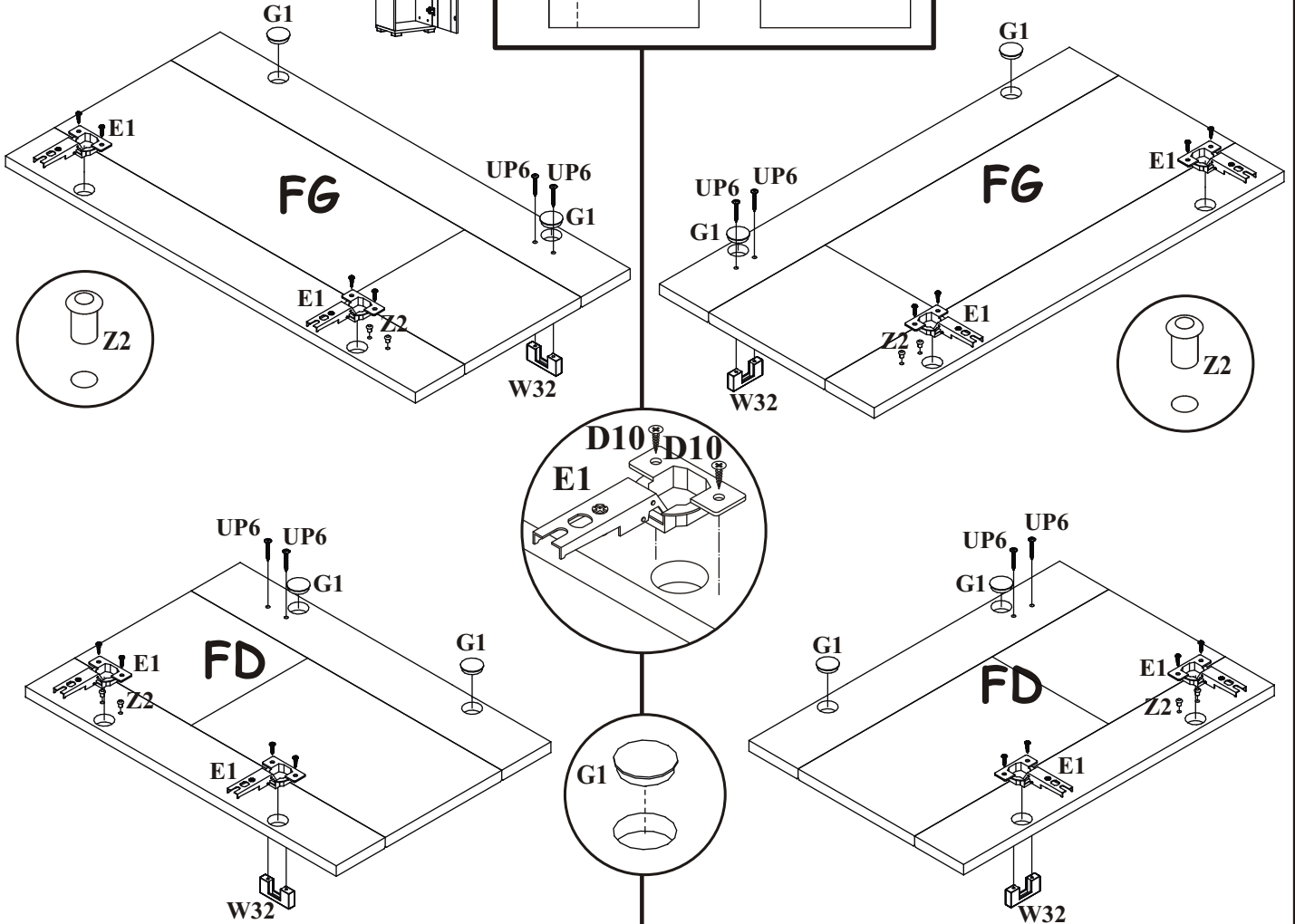
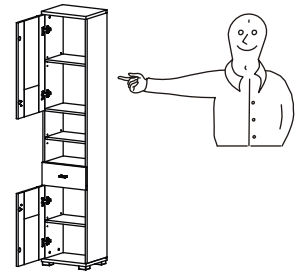

6

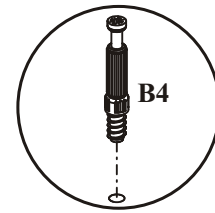
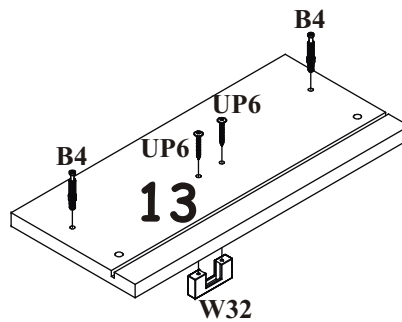

7

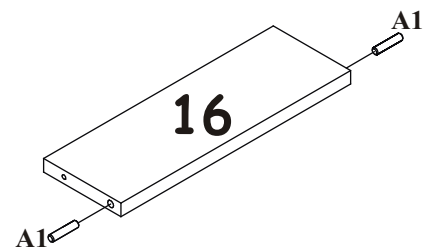
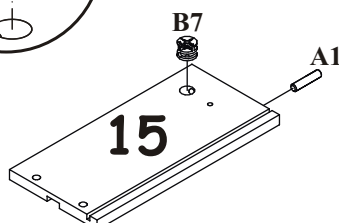
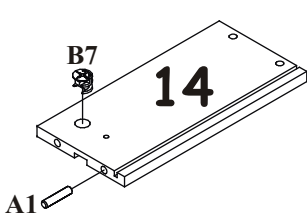
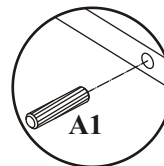
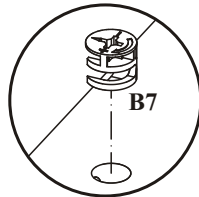
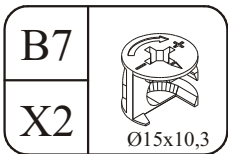

8

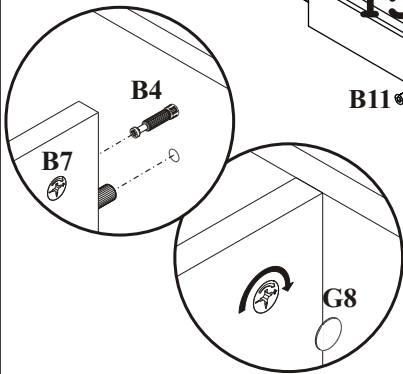
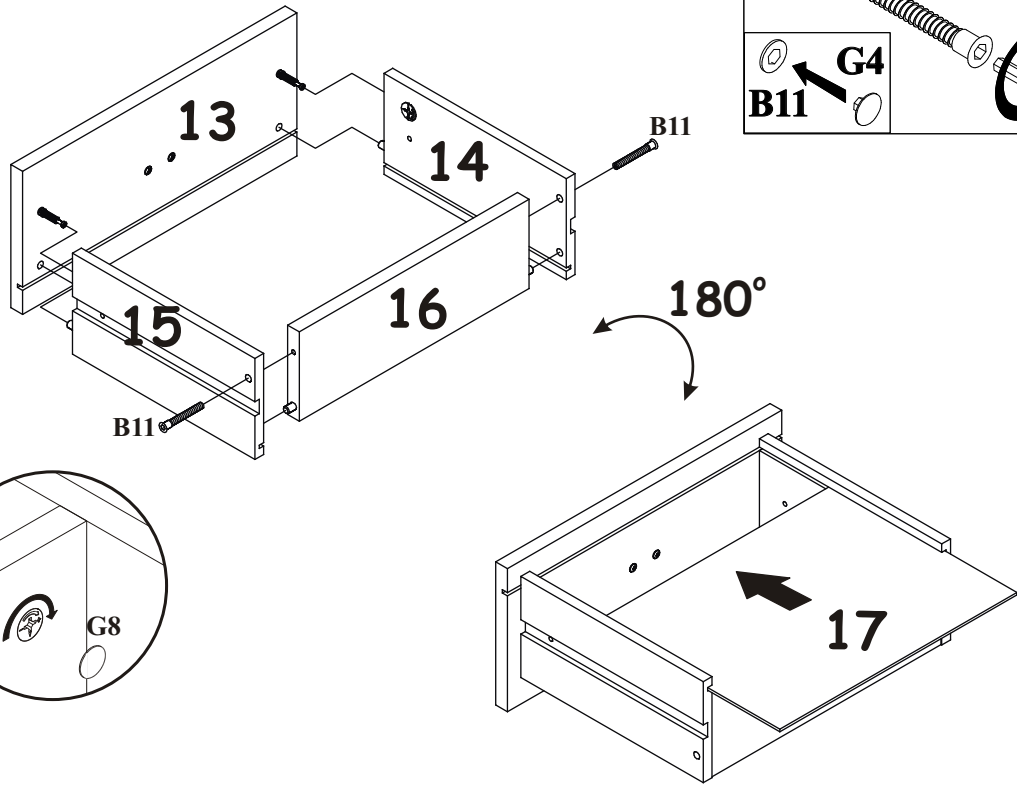
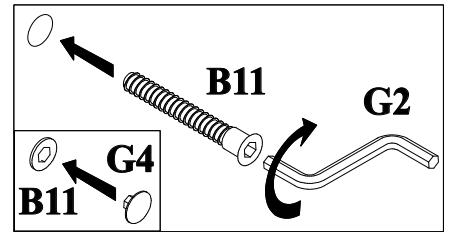

X=Y  $90^\circ$

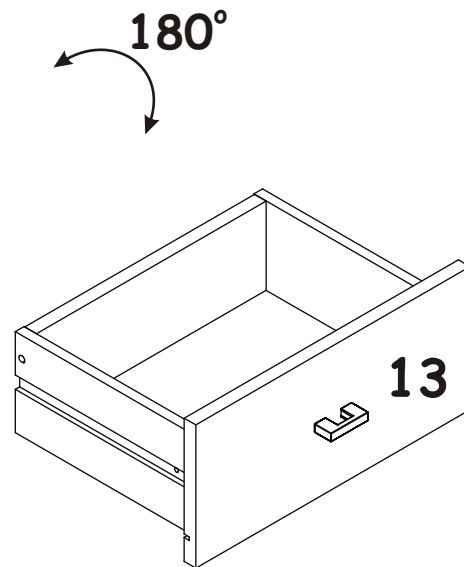
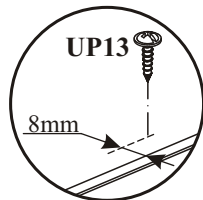
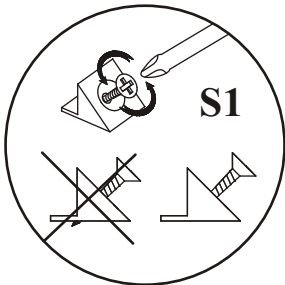
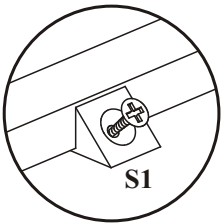
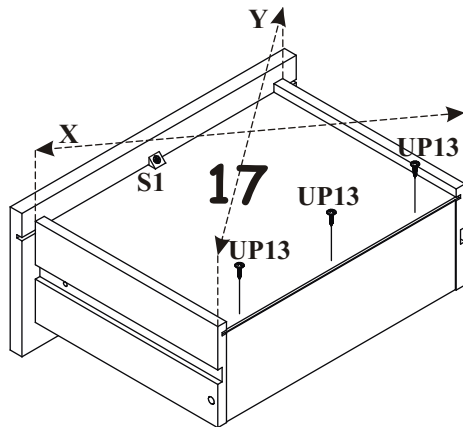

9

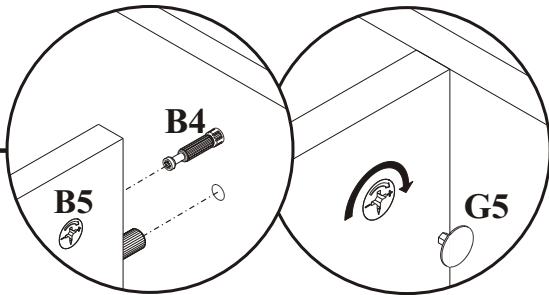
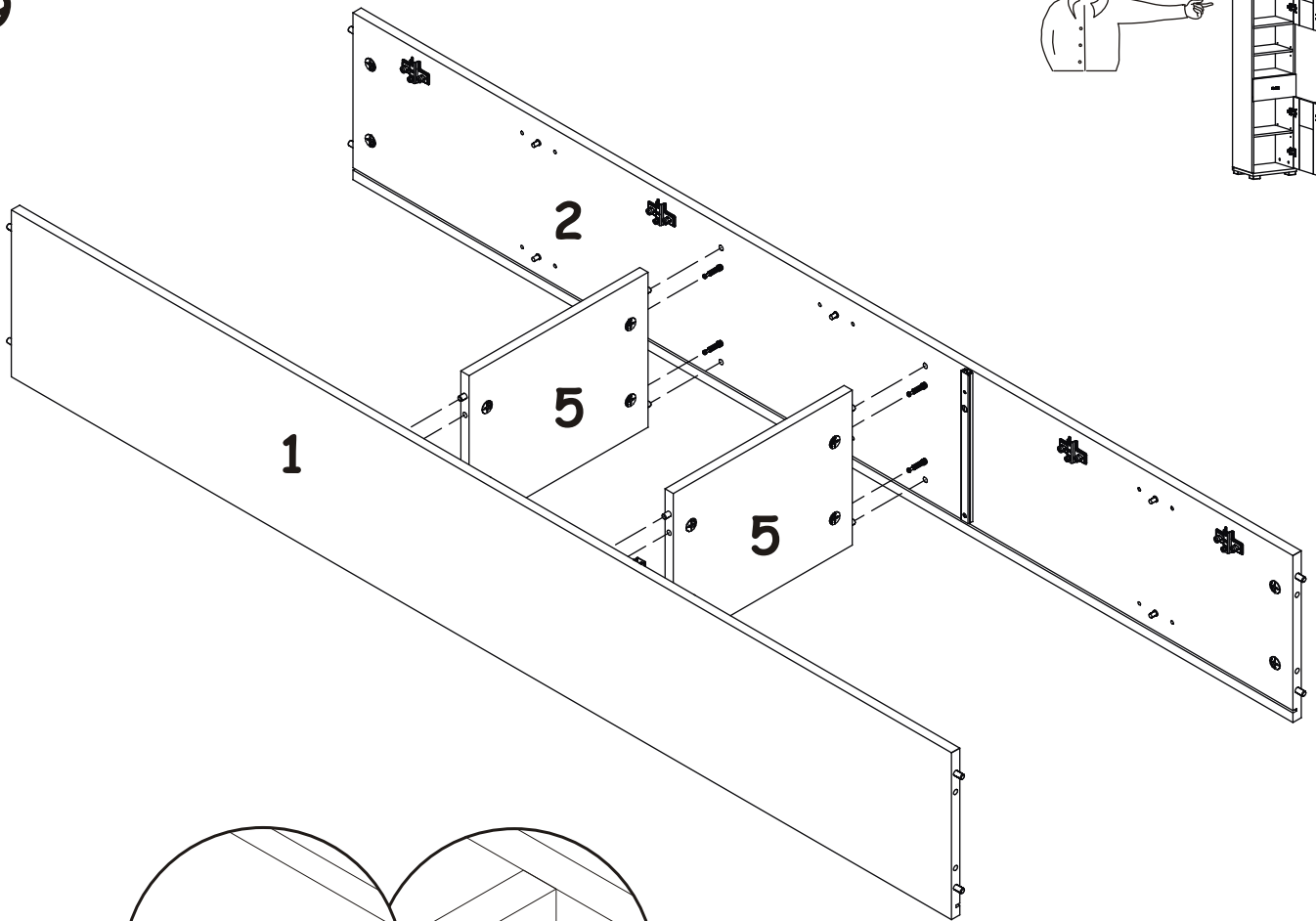

9

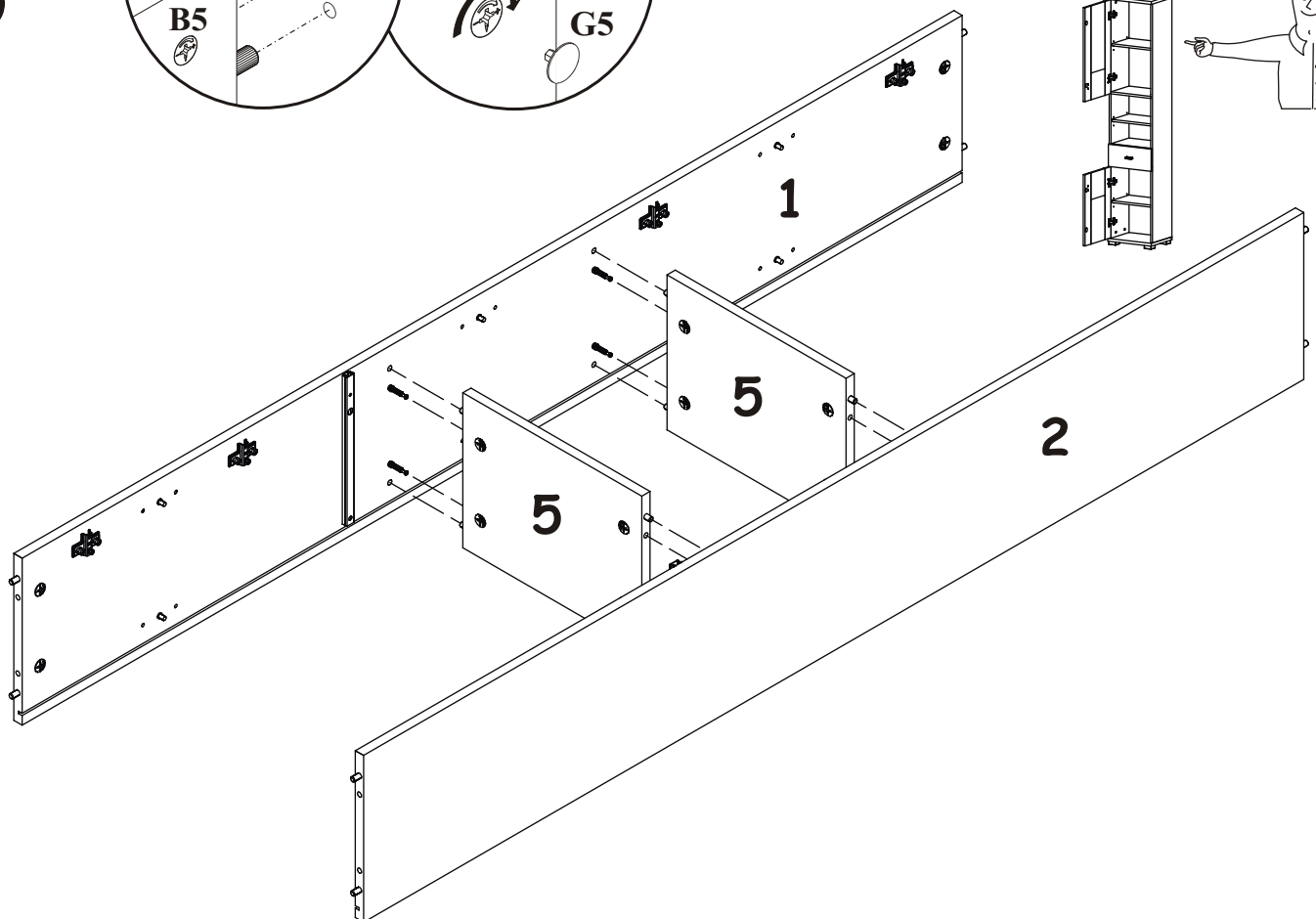



10

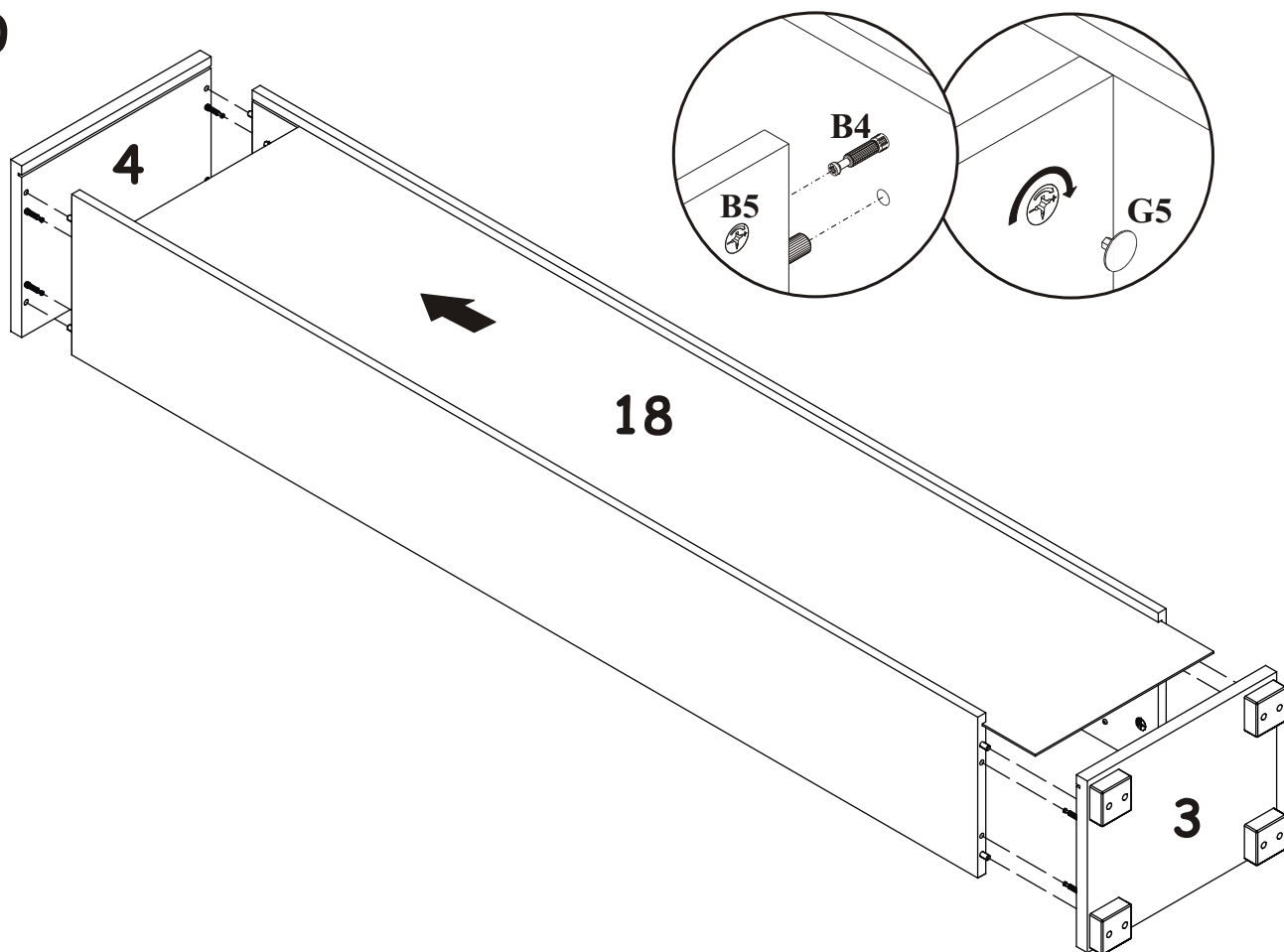

11

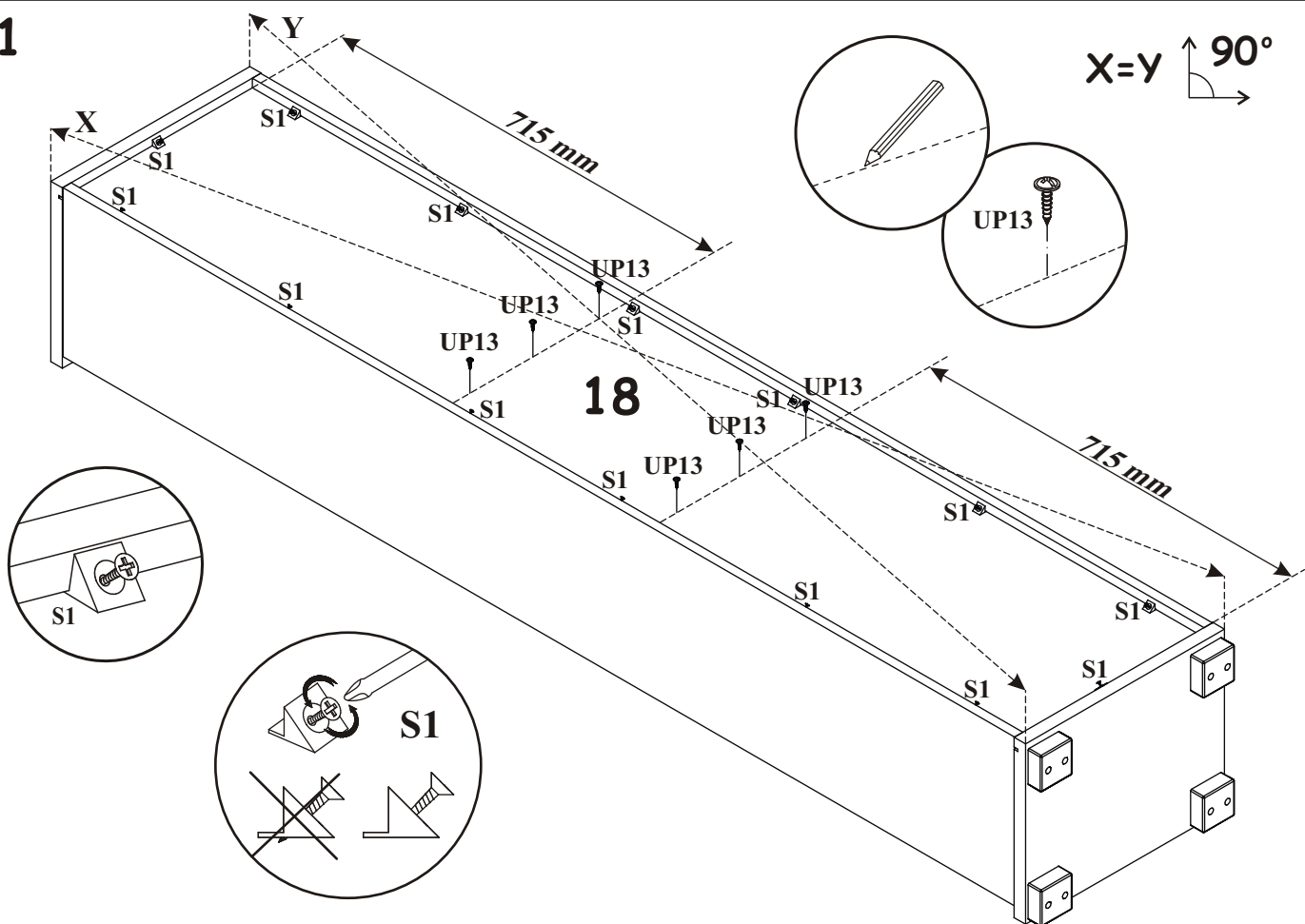

12

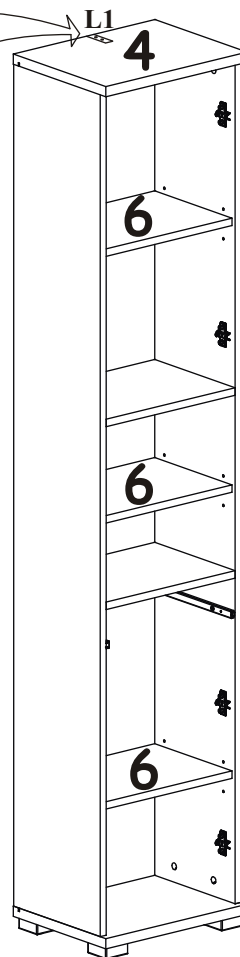
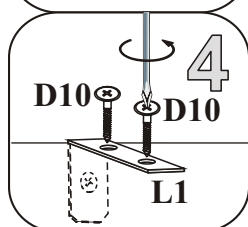
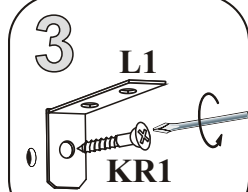
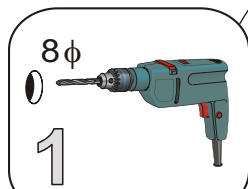
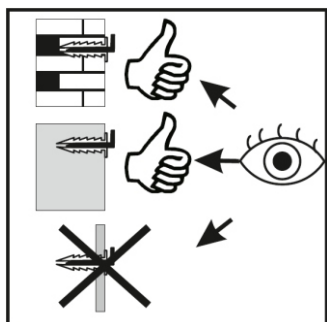

13

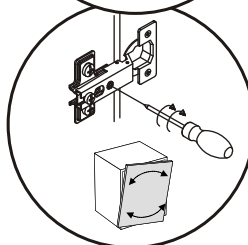
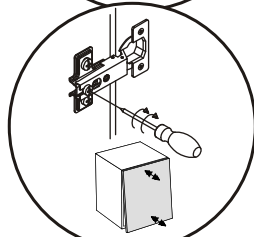
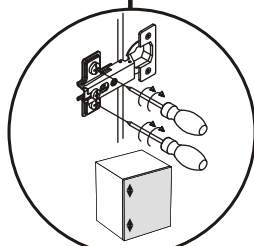
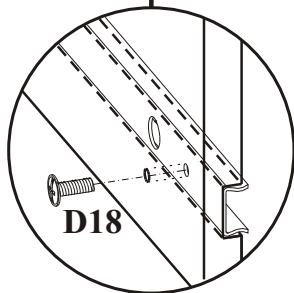
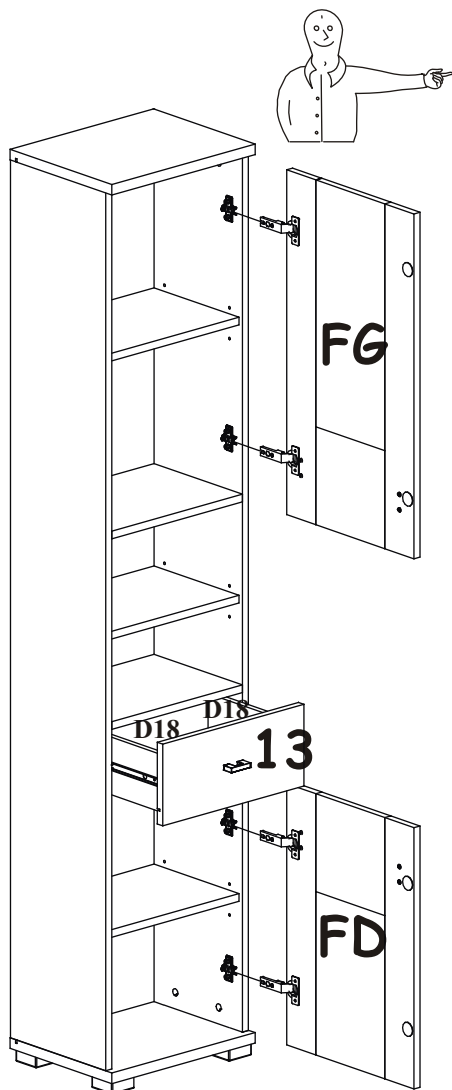

13

