

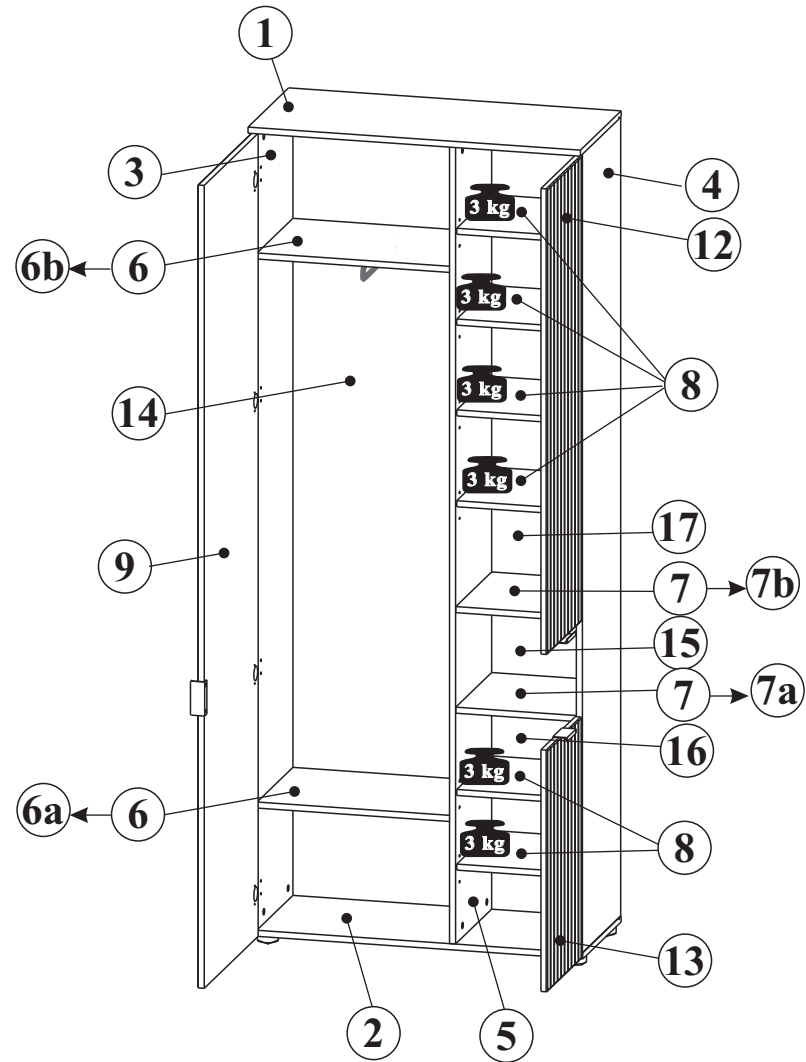

B - 820mm
H - 2025mm
T - 374mm





1	820	374	1	3/3
2	820	353	1	3/3
3	1970	352	1	2/3
4	1970	352	1	2/3
5	1970	332	1	2/3
6	475	330	2	1/3
7	298	330	2	1/3
8	298	320	6	1/3
9	1980	496	1	3/3
12	1148	316	1	1/3
13	596	316	1	1/3
14	1979	487	1	3/3
15	237	310	1	3/3
16	581	310	1	1/3
17	1150	310	1	1/3

NR 1

B1  ϕ 8x28 x28

M1  ϕ 15x12mm x28

T1  5x39mm x28

W1  x24

J23  x22

P2  3x20 x14

F1  x10

C14  ϕ 20mm x24

vito  x1

NR 2

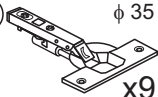
X11  ϕ 35 x9
Kr0

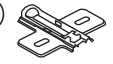
PC  x9
H0

E3  6,3x13 x18

S8  4x13 x18

NR 3

F10  x5

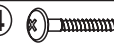
P4  4x25 x5

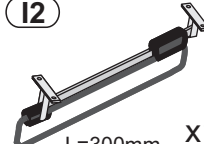
I2  L=300mm x1

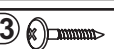
P13  3,5x13 x4

NR 4

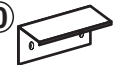
U180  x3

S3A  3,5x13 x6

NR 5

J11  x1

P13  3,5x13 x2

T13  8x50 mm x1

T14  6x50 mm x1

NR 6

SQ 2S  x1

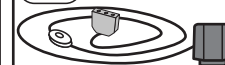
O21  MAX 1,2 W x1

C40  x1

C 1/3

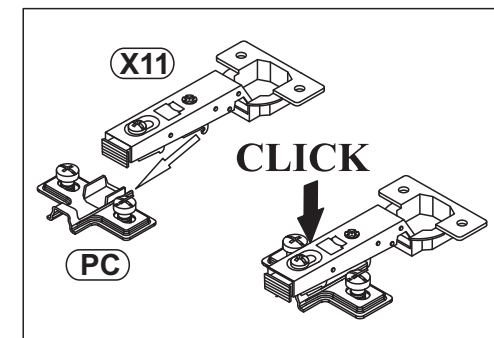
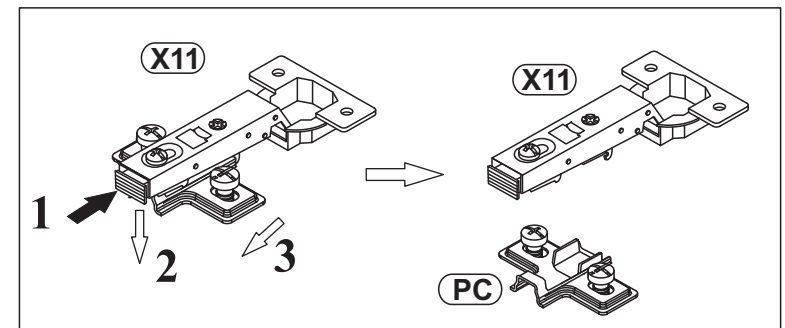

1

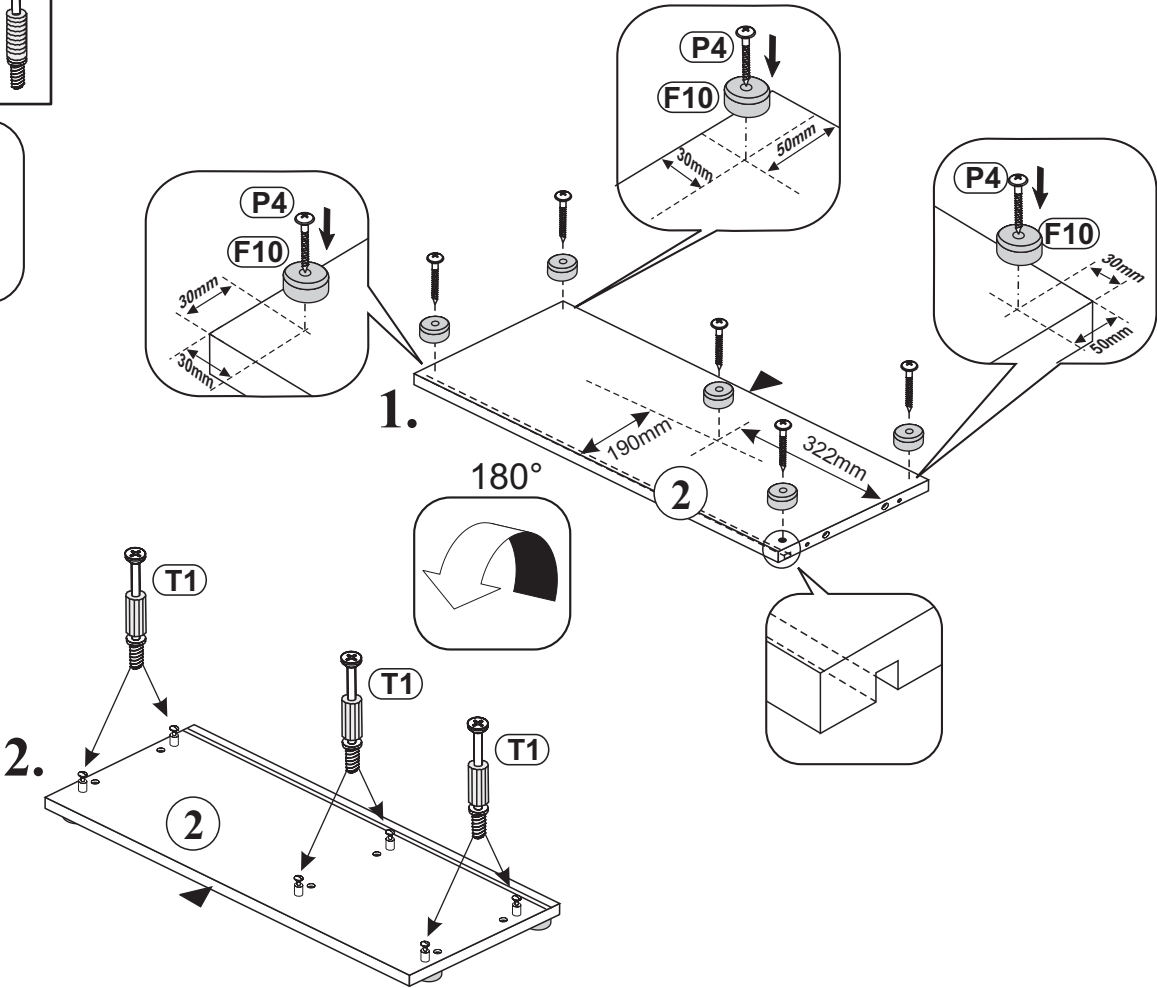
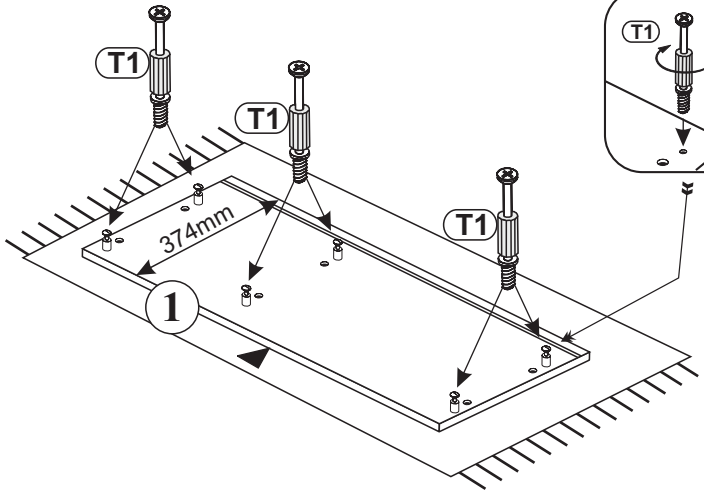
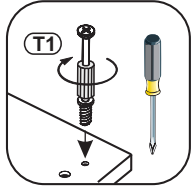
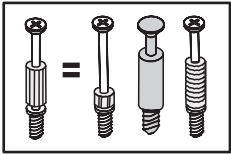
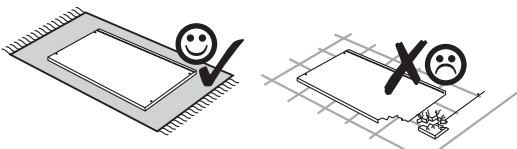
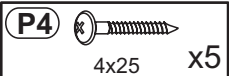
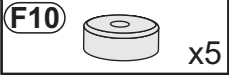
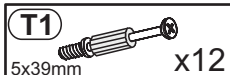

2

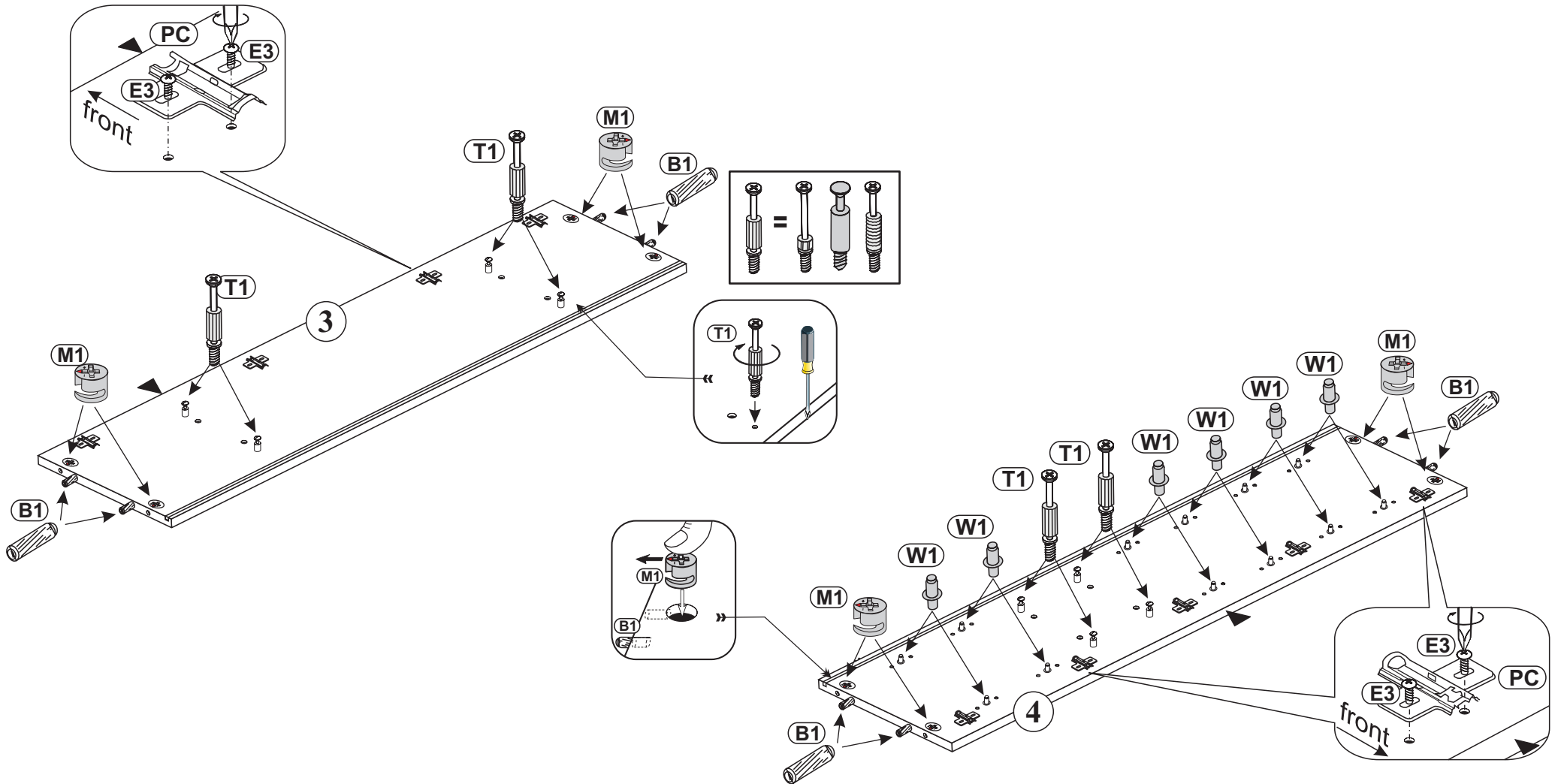
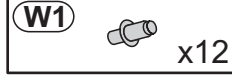
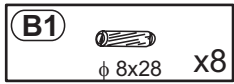
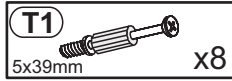
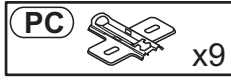
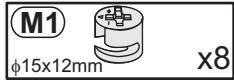

3

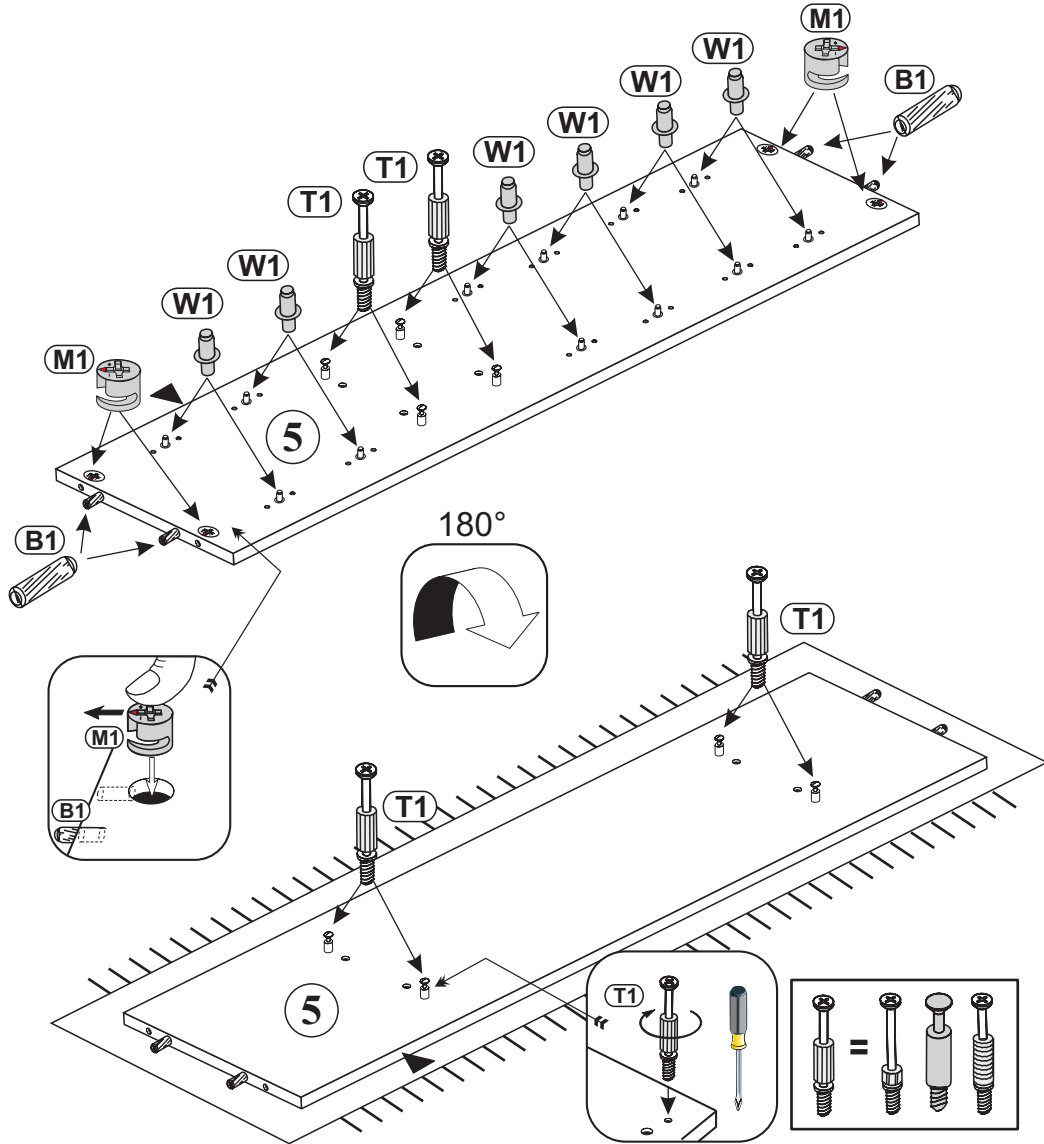
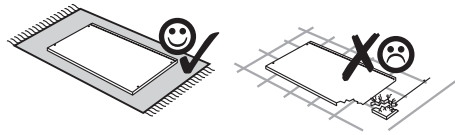
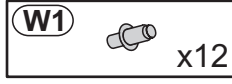
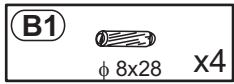
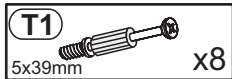
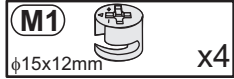

4

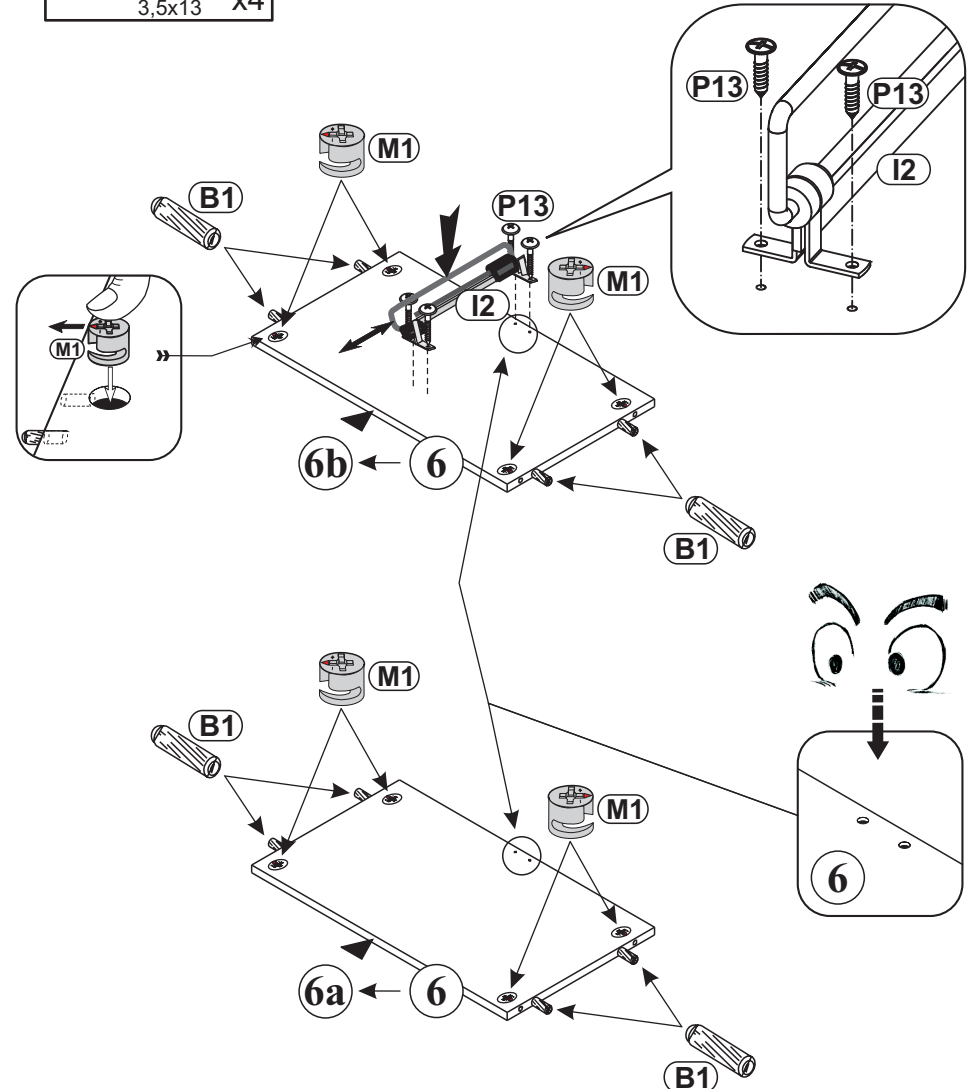
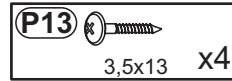
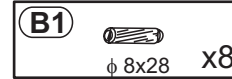
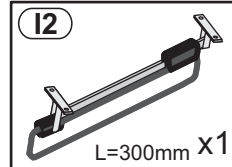

5

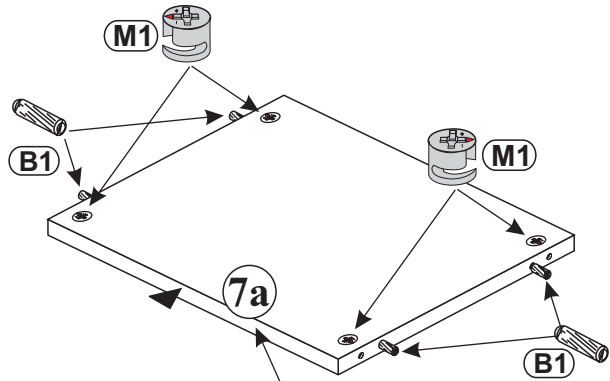
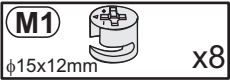
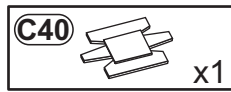
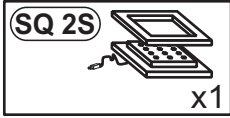
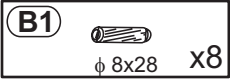

7 x2

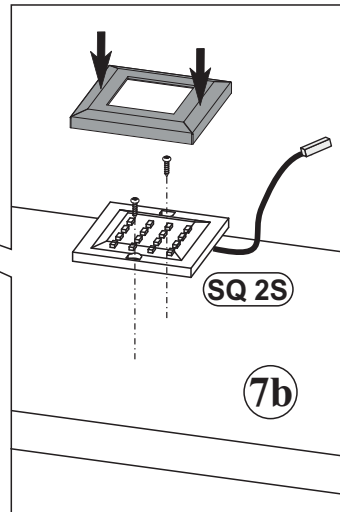
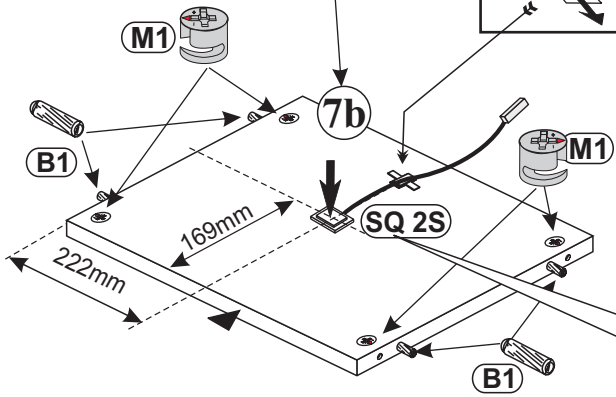
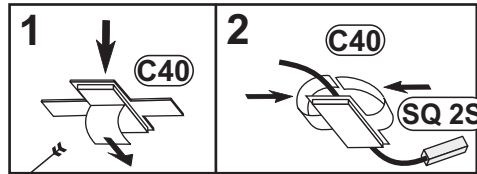

6

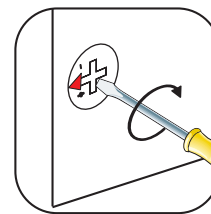
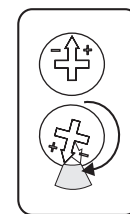
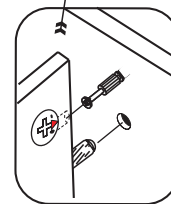
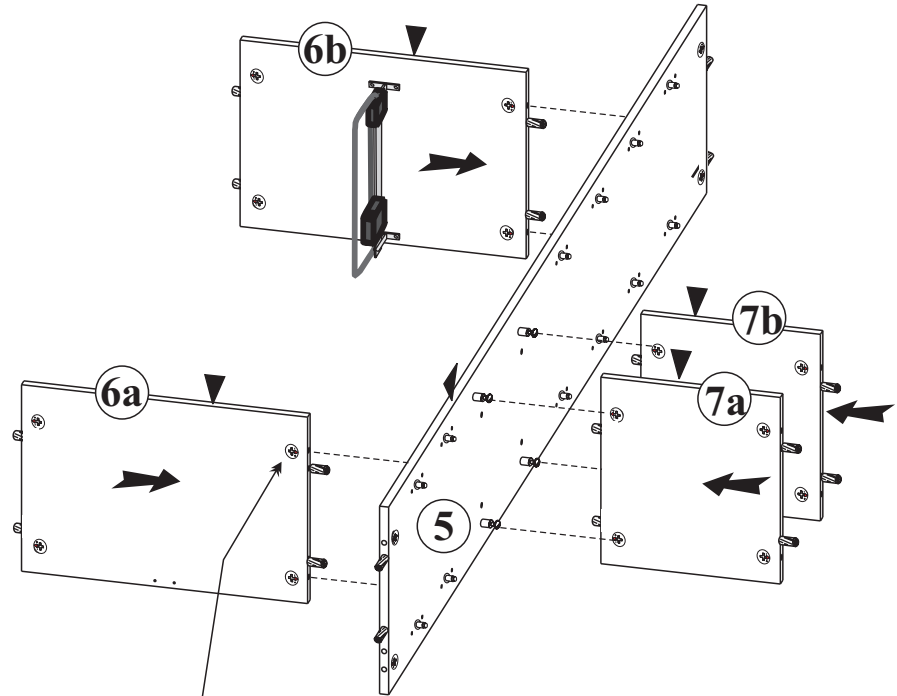

7

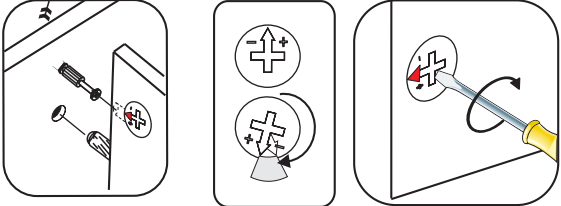
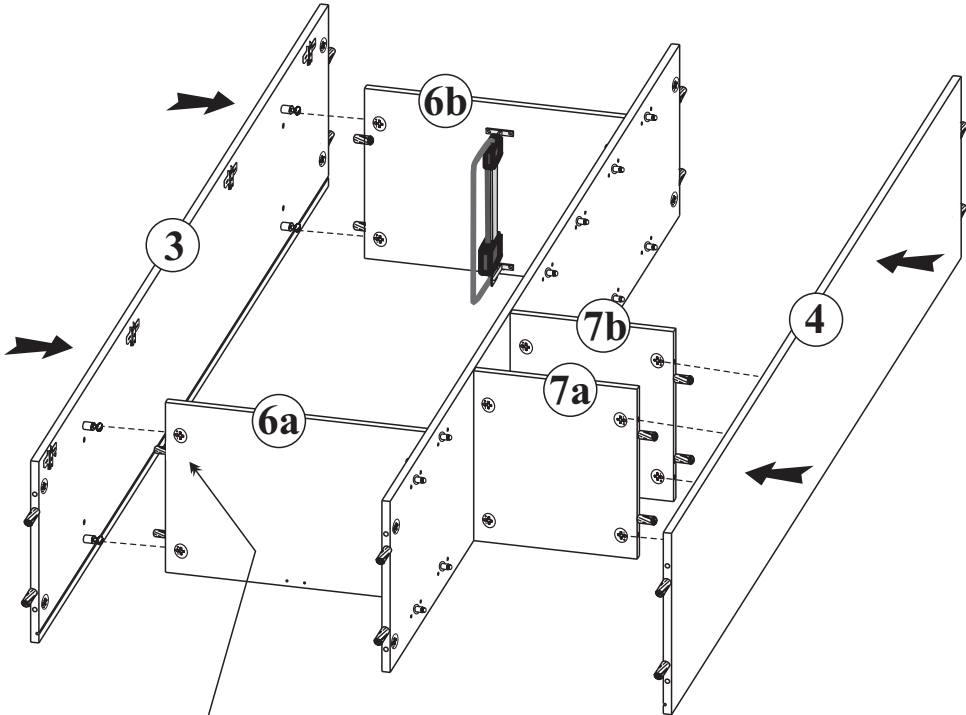

8

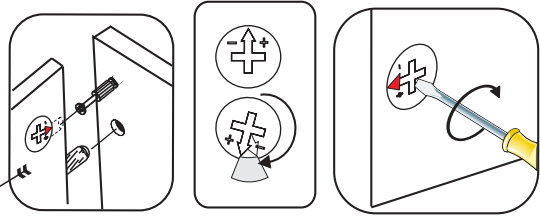
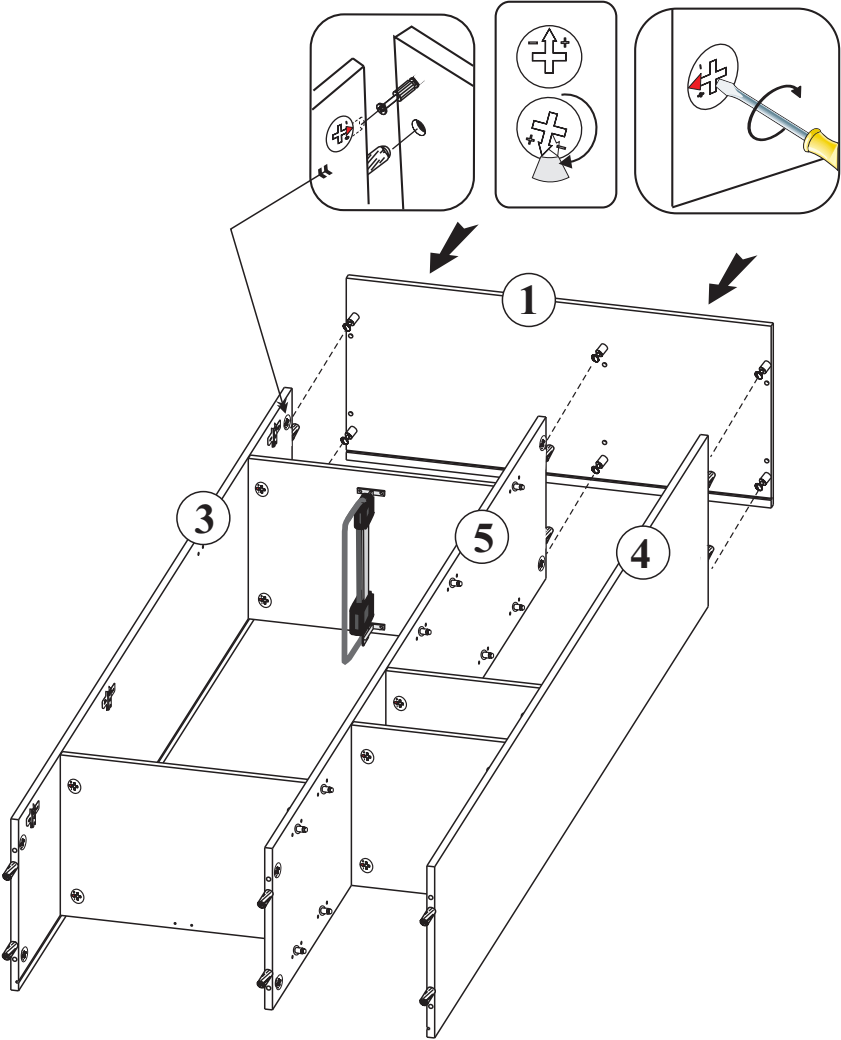

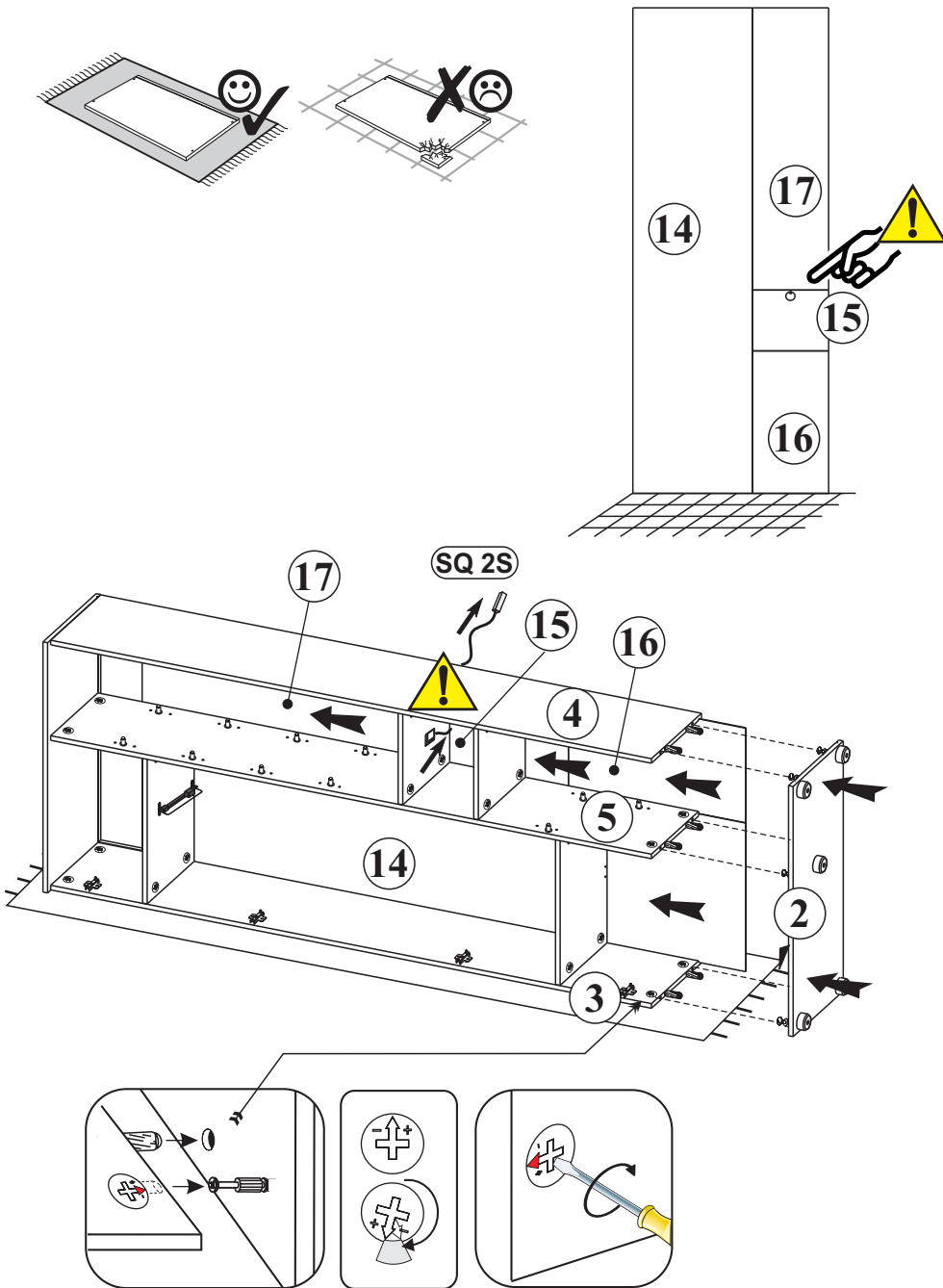

9

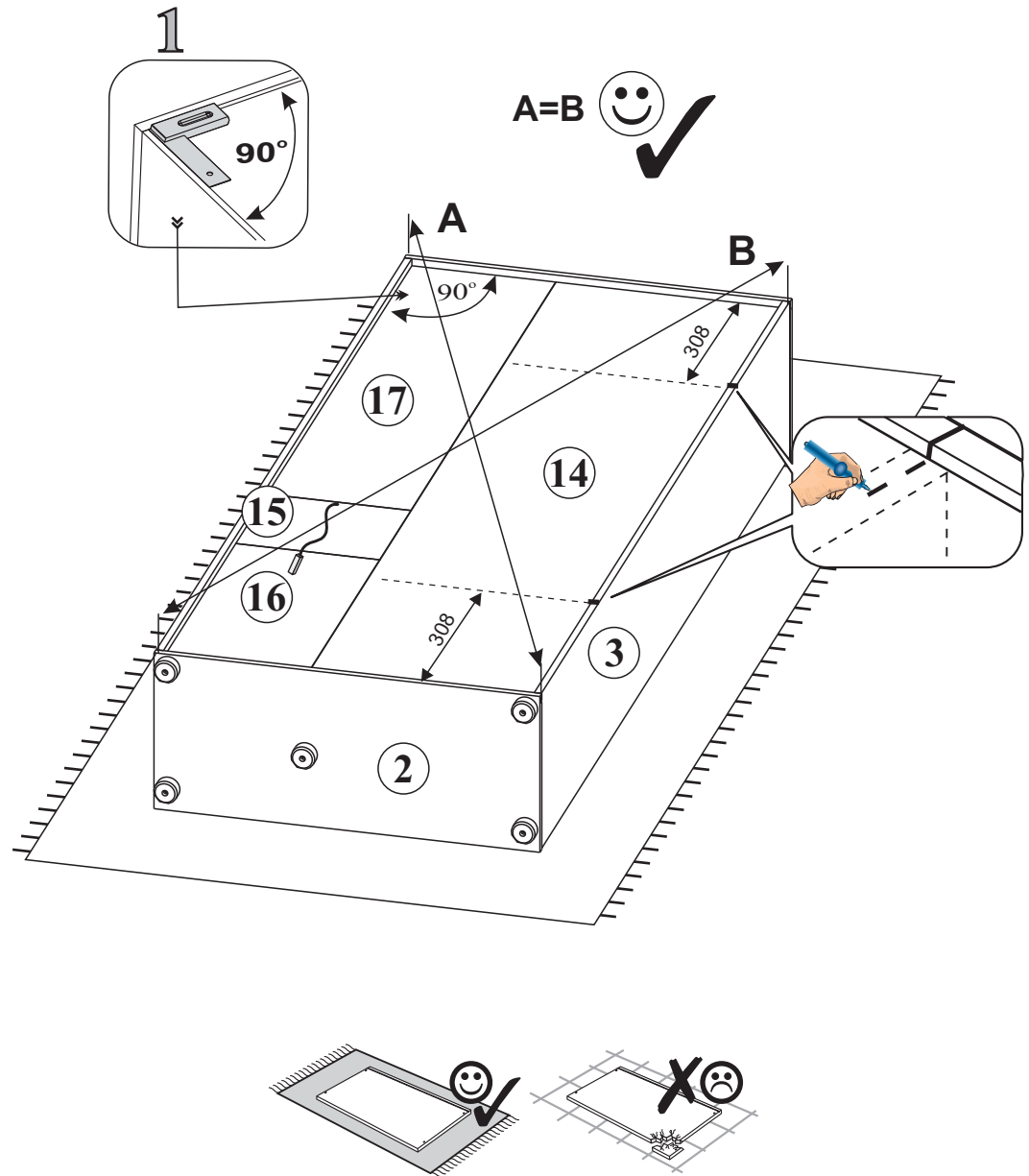

10





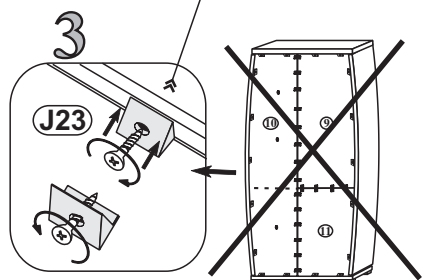
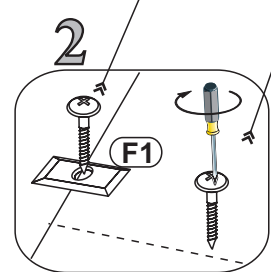
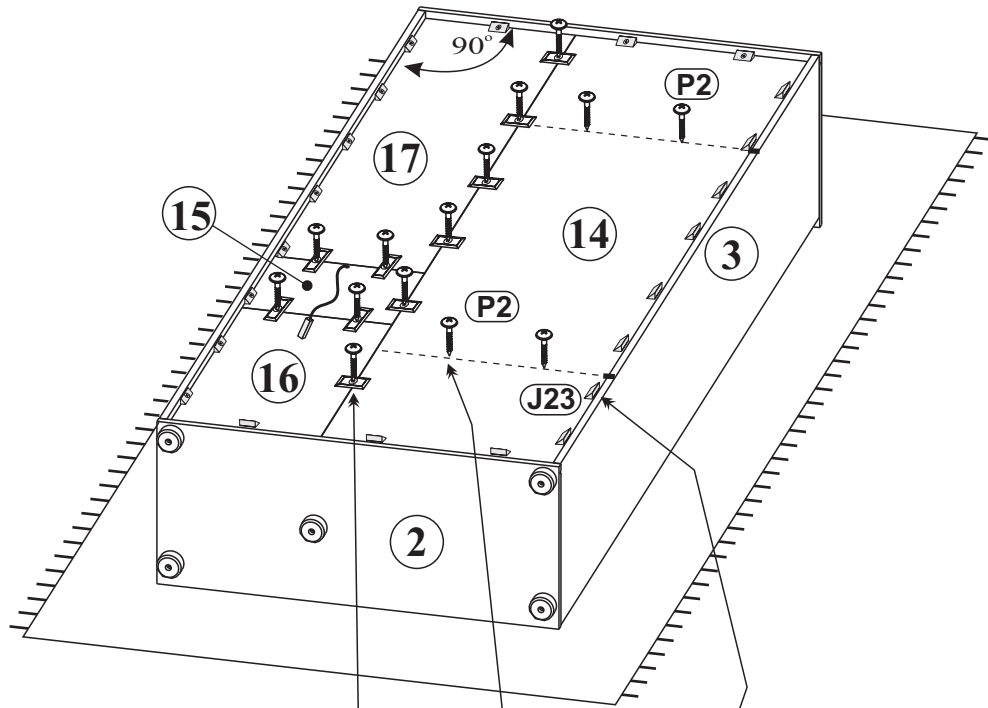
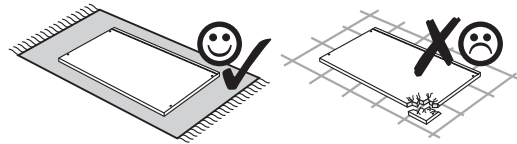

11

- J23**  x22
- P2**  3x20 x14
- F1**  x10



12

- T14**  6x50 mm x1
- T13**  8x50 mm x1
- P13**  3,5x13 x2
- J11**  x1

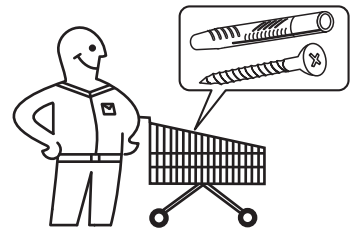
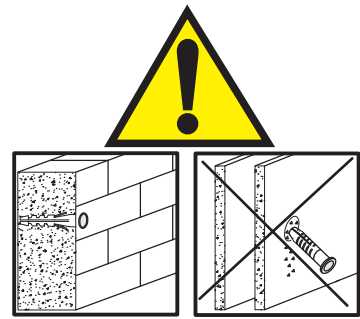
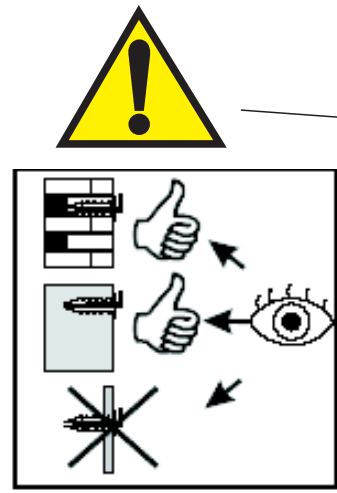
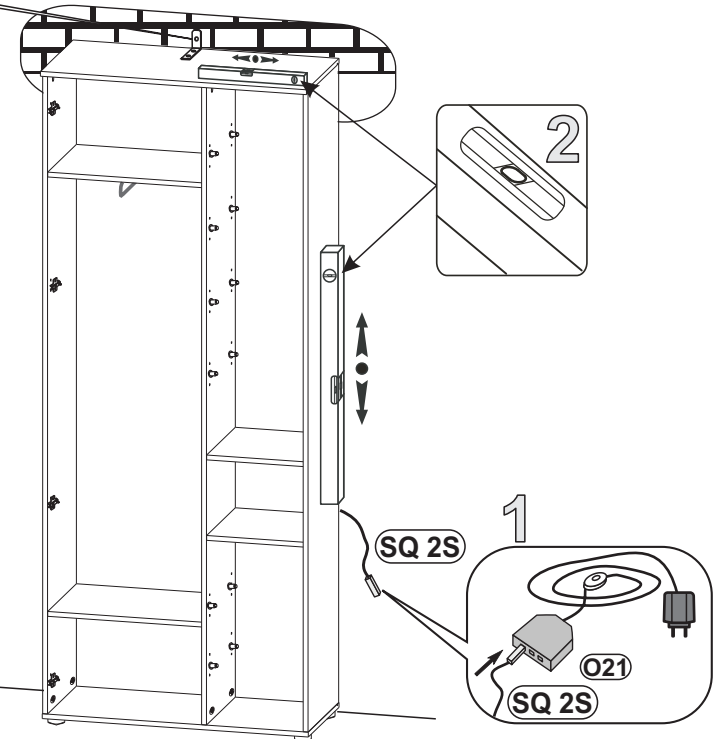
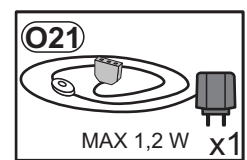
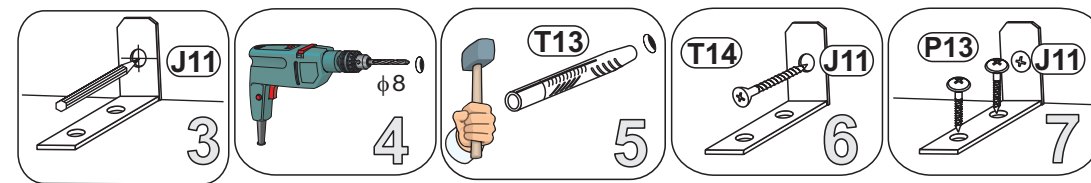

13

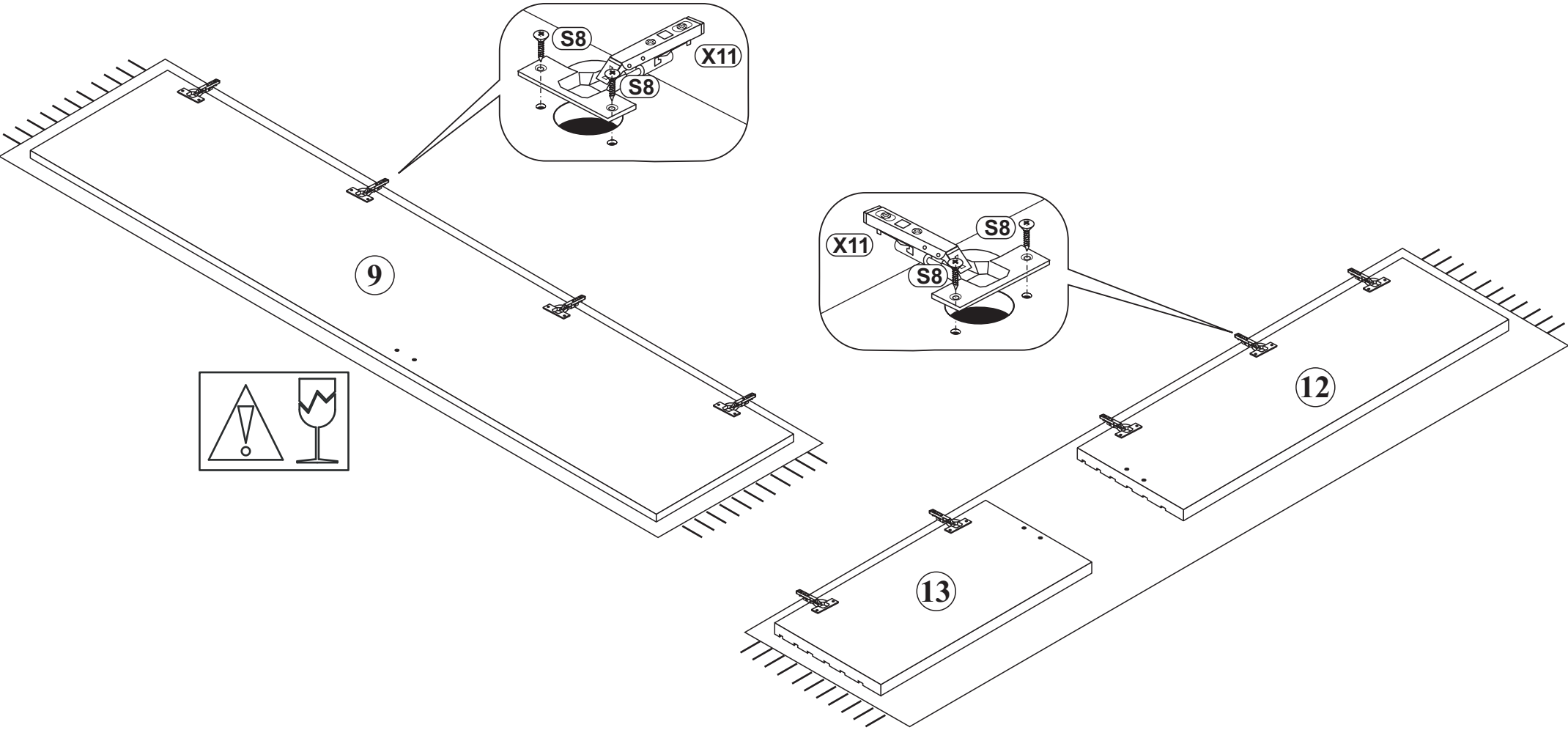
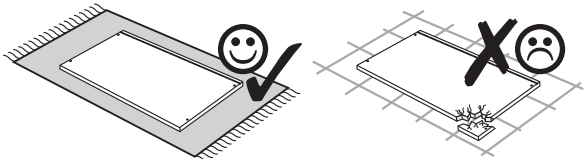
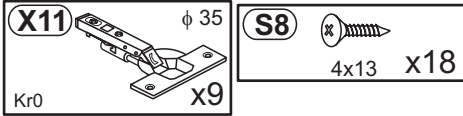

14

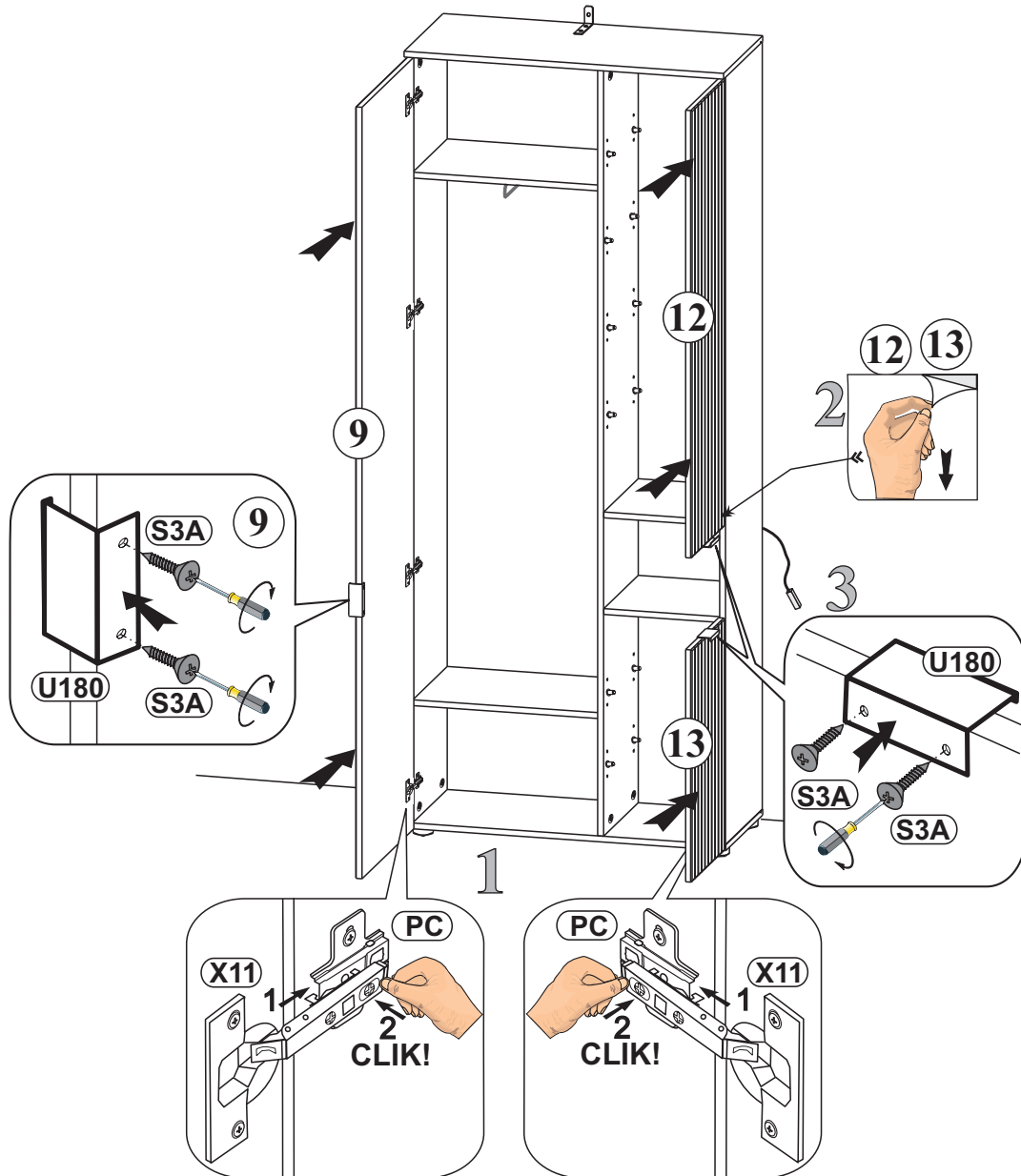
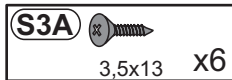

15

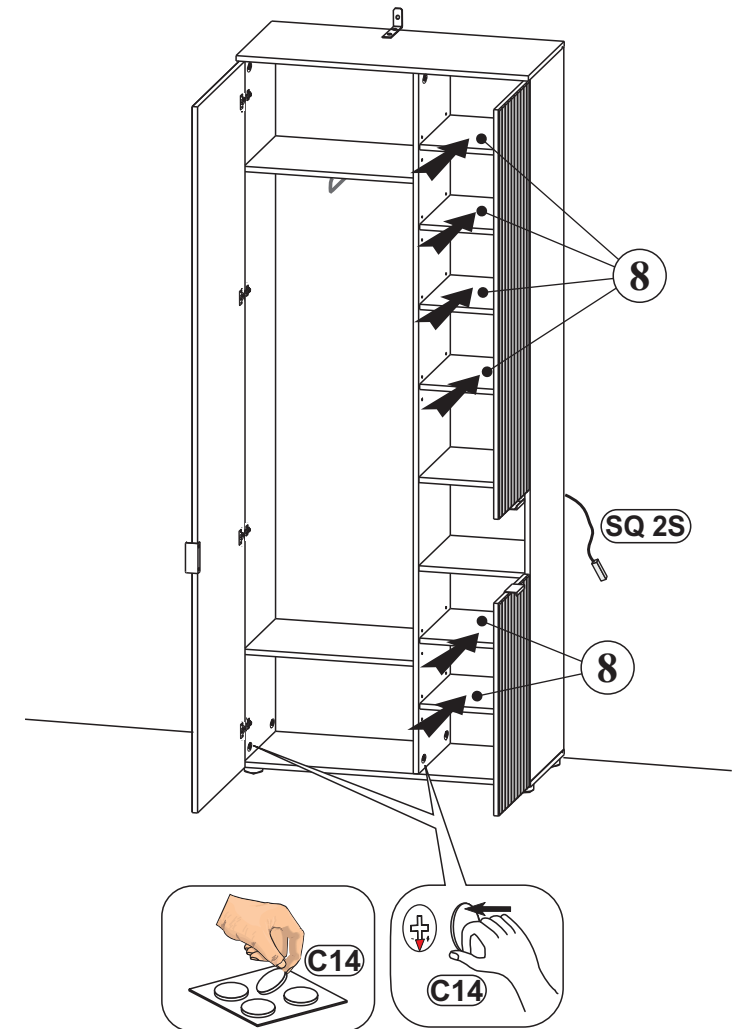
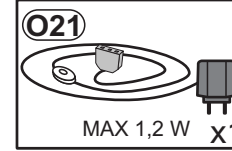
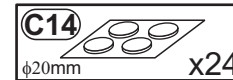

16

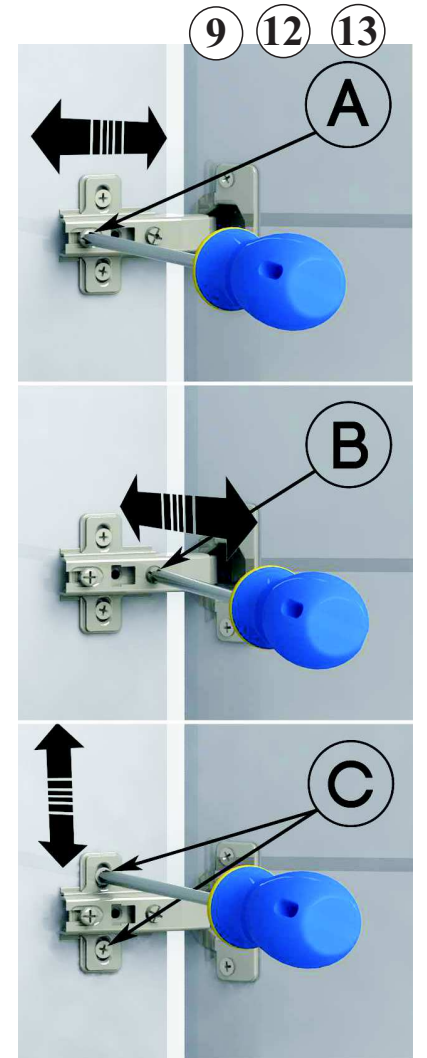
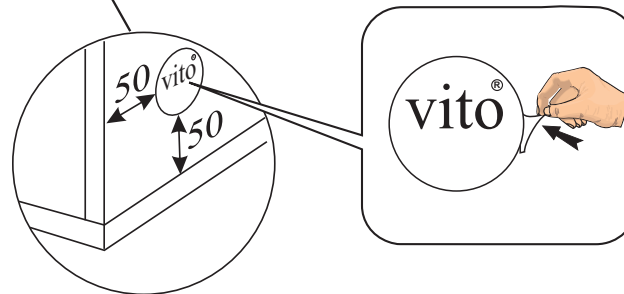
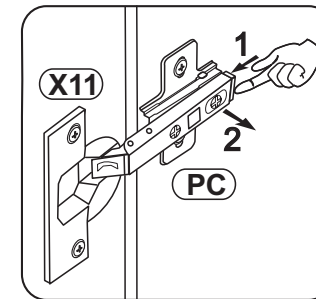
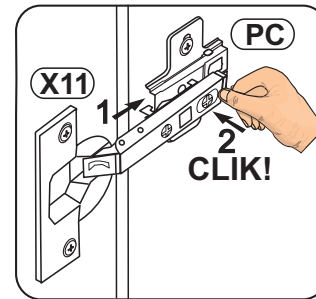
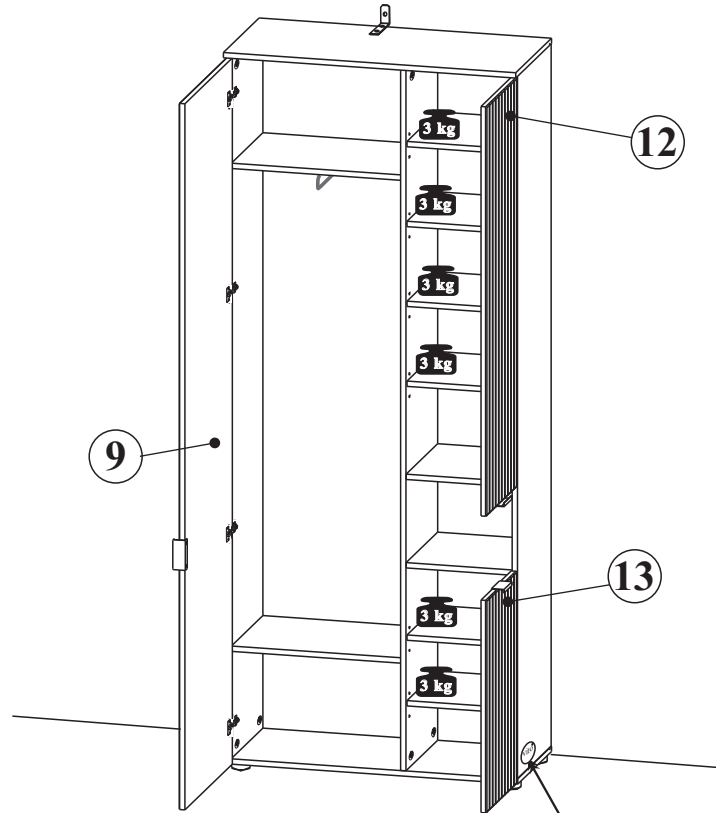
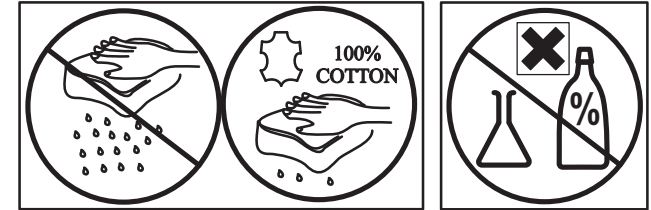

82

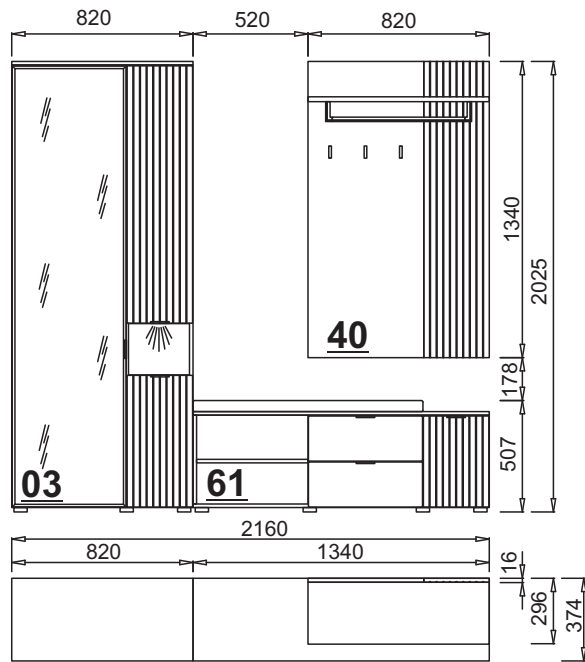

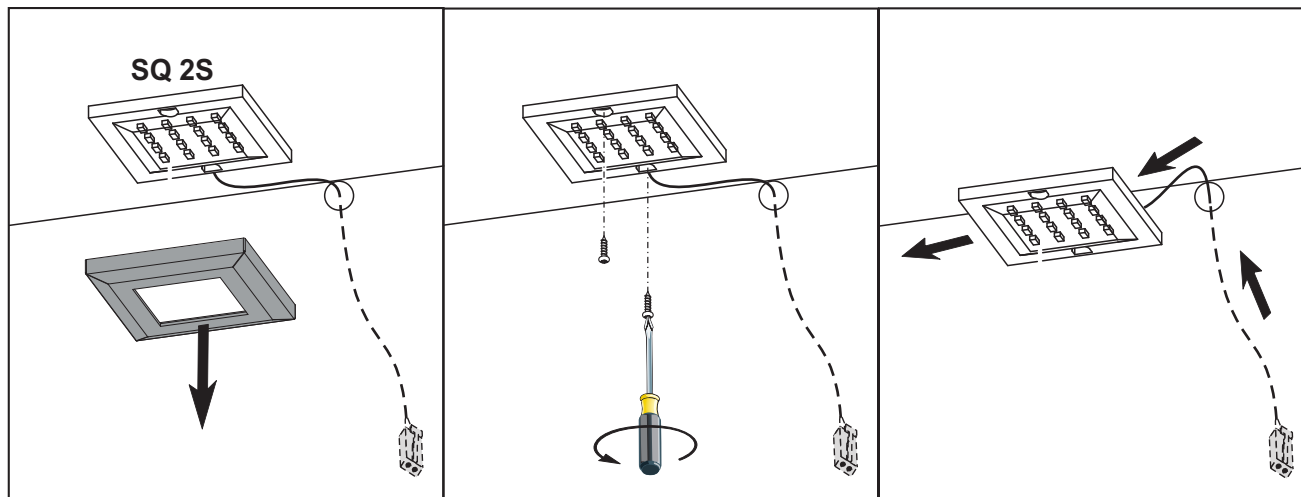

787846 SQUERE2S-PCB-NW

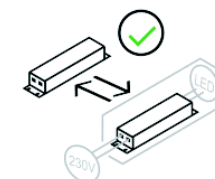
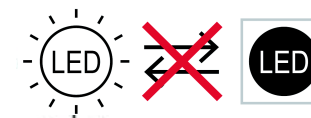

PL- Ten produkt zawiera źródła światła o klasie efektywności energetycznej „F”

DE- Diese Produkte enthalten Lichtquellen der Energieeffizienzklasse „F”

CS- Tento výrobek obsahuje světelný zdroj třídy energetické účinnosti „F”

DA- Dette produkt indeholder en lyskilde til energieffektivitetsklasse „F”

EL- Αυτό το προϊόν περιέχει μια πηγή φωτεινής πηγής ενεργειακής απόδοσης „F”

EN- This product contains a light sources of energy efficiency class „F”

ES- Este producto contiene una fuente de luz de clase de eficiencia energética „F”

ET- See toode sisaldab efektiivsusklassi valgusallikat energia "F”

FI- Tämä tuote sisältää energiatehokkuusluokan valonlähteen „F”

FR- Ce produit contient des sources lumineuses de classe d'efficacité „F”

HU- Ez a termék energiahatékonysági osztályú fényforrást tartalmaz „F”

IT- Questo prodotto contiene una sorgente luminosa di classe di efficienza energetica „F”

LT- Šiame gaminyje yra energijos vartojimo efektyvumo klasės šviesos šaltinis „F”

LV- Šis produkts satur gaismas avotu ar energoefektivitātes klasi „F”

RU- Этот продукт содержит источник света класса энергоэффективности „F”

PT- Este produto contém uma fonte de luz da classe de eficiência energética „F”

RO- Acest produs conține o sursă de lumină de clasă de eficiență energetică „F”

NL- Dit product bevat een lichtbron met energie-efficiëntieklasse „F”

SK- Tento výrobek obsahuje svetelný zdroj triedy energetickej účinnosti „F”

SLO- Ta izdelek vsebuje svetlobni vir razreda energijske učinkovitosti „F”

SV- Denna produkt innehåller en ljuskälla för energieffektivitetsklass „F”

TR- Bu ürün bir ışık kaynağı enerji verimliliği sınıfı içerir „F”

HR- Ovaj proizvod sadrži izvor svjetlosti razreda energetske učinkovitosti „F”

BG- Този продукт съдържа източник на светлина от клас на енергийна ефективност „F”

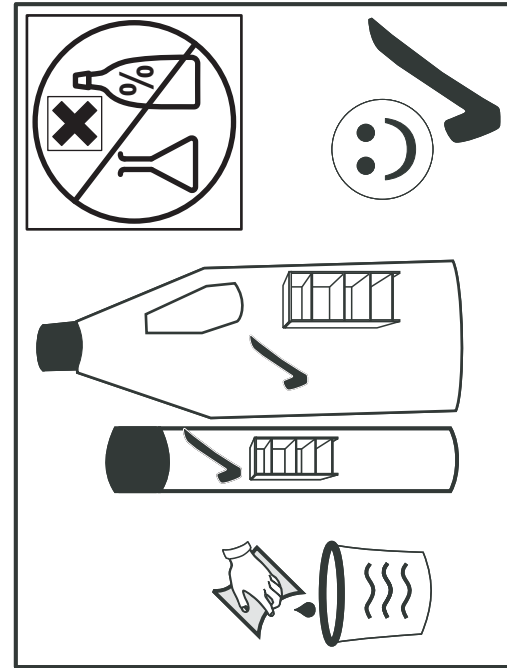
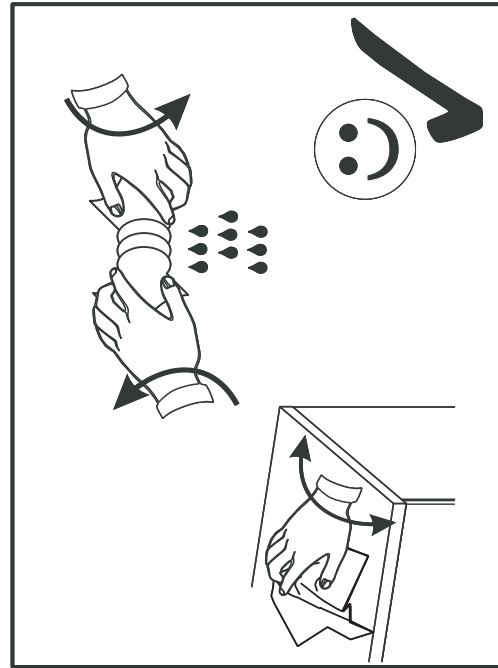
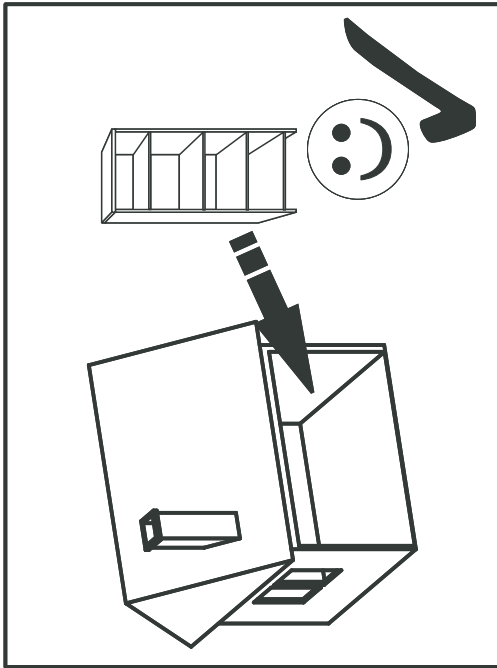
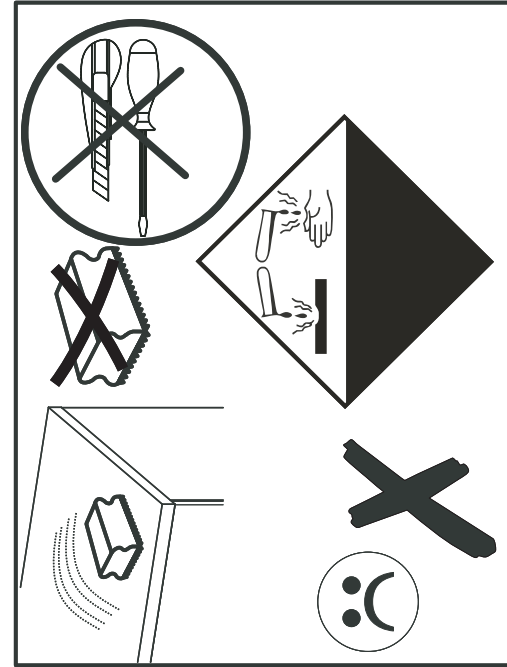
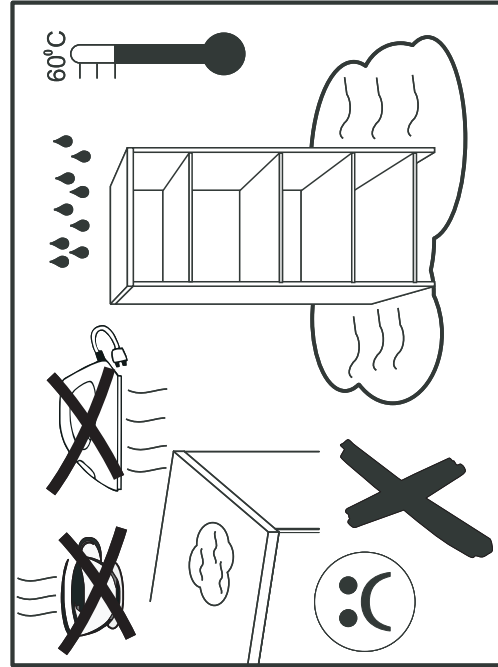
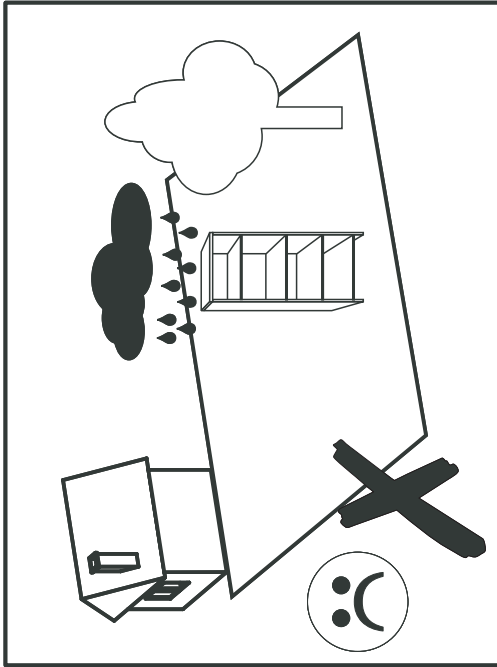
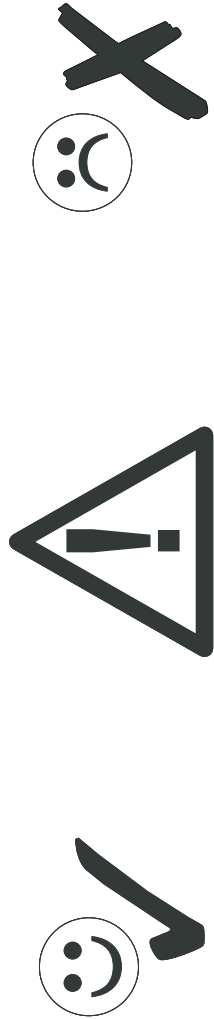

D CH AT LI LU Kleinstele und Verpackungsfolien bei der Möbelmontage von Kindern fernhalten!
GB US Keep small parts and plastic film out of the reach of children!
FR BE NC Tenir les petites pièces et les films plastiques hors de la portée des enfants!
NL Hou de kleine onderdelen en de plastic folie uit de buurt van kinderen!
IT Tenere i componenti di piccole dimensioni e le pellicole di plastica fuori dalla portata dei bambini!
SI Malhni delov i foliju za pakovanje folije pri montaži pohištna priane izven dosega otrok!
XS HR BA Malje dijelove i foliju za pakovanje priklom montaže namještaja držite dalje od djece
HU Bútorészeket közbden a kis alkatrészek és a csomagoló fóliák gyerekekkel távol tartandók!
BG Дребни детайли и опаковъчни фолиа да се държат далеч от деца при монтажа на мебелите!
CZ SK Přední detaily i obalovací materiál při montáži nábytku držte dále od dětí
SE Vid möbelförpackningen ska smådelar och förpackningsfolien hållas oåtkomliga för barn!
RO Țineți departe de copil piesele mici și folia de ambalat la montarea mobilierului!
ES ¡Durante el montaje, mantenga alejados de los niños las piezas pequeñas y el material plástico de embalaje!

D CH AT LI LU Möbelmontage muss auf ebennem Untergrund erfolgen. Bei Wandmontagen immer geeignetes Befestigungsmaterial verwenden.
GB US Furniture must be assembled on a flat surface. For assembly to the wall only use suitable fixing materials.
FR BE NC Le meuble doit être monté sur une surface plane. Pour le montage mural, utilisez des accessoires de fixation adaptés au type de mur.
NL De meubels dienen op een vlakke ondergrond te worden gemonteerd. Voor wandmontage moeten geschikte bevestigingsmaterialen worden gebruikt.
IT Il montaggio dei mobili deve avvenire su un fondo piano. Per il montaggio si prega di utilizzare solo materiali adatti.
SI Pohištno je treba montirati na ravni podlagi. Pri stenski montaži vedno uporabite pritrilveni material.
XS HR BA Namještaj se mora montirati na ravnoj podlozi. Kod montaže na zid uvijek koristite prikladan materijal za pričvršćivanje.
HU A bútorcszerelési silk felületen kell végezni. Falra szereléshez mindig megfelelő rögzítianyagot kell használni.
BG Монтажът на мебелите да се извършва на равна основа. При стенен монтаж винаги да се използва подходящ крепежен материал.
CZ SK Montáž nábytku provádějte na rovném podkladu. Při montáži na stěnu používejte vždy vhodný přírbovací materiál.
SE Monteringen av möbelen måste göras på jämnt underlag. Vid väggmontering ska lämpligt uppfästingsmaterial användas.
RO Montarea mobilierului trebuie să se realizeze pe o pardoseală dreaptă. La montarea la perete utilizați întotdeauna material de fixare adecvat.
ES El montaje debe efectuarse sobre una superficie uniforme. En el montaje mural emplee siempre el material de fijación adecuado.

D CH AT LI LU Bitte beachten Sie die Montageanleitung. Halten Sie immer die angegebene Wattzahl ein. Verhindern Sie einen Hitzestau.
GB US Please observe the assembly instructions. Do not exceed the max. given wattage. Ensure that the heat is not allowed to build up.
FR BE NC Veuillez respecter la notice de montage. Respectez impérativement le nombre des watts maximal. Veillez à éviter toute accumulation de chaleur.
NL Lees a.u.b. de montagehandleiding door. Hou de beslist aan het max. opgegeven wattage. Zorg ervoor dat geen hittehuwng onstaat.
IT Attenersi alle istruzioni di montaggio. Rispettarsi rigorosamente il numero di watt max. indicato. Assicurarsi che non si verifichi un accumolo di calore.
SI Upštevalje navodila za montažo. Vedno upštevalje navedeno številco vatov. Preprečite zastoj vročine.
XS HR BA Obratite pažnju! Vas pozor na uputu za montažu. Uvijek se pridržavajte navedenog broja vai. Izbjegavajte zastoj vrućine.
HU Vegye figyelembe a szerelési útmutatót. Mindig tartsa be a megadott wattszámot. Akadályozza meg a hőelődést.
BG Моля, вземете под внимание ръководството за монтаж. Спазвайте винаги посочените ватове. Избягвайте акумулиране на топлина.
CZ SK Dodržujte prosím návod k montáži. Vždy dodržujte uvedenou hodnotu výkonu (watt). Zabráňte tak přehřívání.
SE Följ monteringsanvisningen. Följ alltid angivet watttal. Undvik att hetta uppstår.
RO Respectați instrucțiunile de montaj. Respectați întotdeauna numărul de watt impus. Evitați acumularea de căldură.
ES Le rogamos que tenga presente las instrucciones de montaje. Respete siempre el número indicado de vatios. Evite la acumulación de calor.

D CH AT LI LU Halten Sie die max. zulässigen Belastungswerte der Möbelteile ein. Details siehe Montageanleitung
GB US Comply with the max. permissible loads. For details, please refer to the assembly instructions
FR BE NC Respectez les valeurs de charge max. admissibles des parties de meubles. Pour plus de détails, cf. la notice de
NL Hou de maximaal geoorloofde belastingwaarden van de meubeldelen aan. Voor details verwijzen wij naar de montagehandleiding
IT Rispettare la portata max. permessa degli elementi del mobile. Per dettagli si vedano le istruzioni di montaggio e si vada
SI Upštevalje največjo dovoljeno obremenitev delov pohištna. Podrobnosti najdete v navodilih za montažo in na
XS HR BA Tartsa be a bútorelemek max. megengedett terhelési értékeit. A részleteket lásd a szerelési útmutatóban
HU Tartsa be a bútorelemek max. megengedett terhelési értékeit. A részleteket lásd a szerelési útmutatóban
BG Спазвайте макс. допустимите стойности на натоварване на мебелите. За подробности виж ръководството за монтаж
CZ SK Dodržujte max. přípustné hodnoty zatížení nábytkových dílů. Podrobnosti viz návod k montáži
SE Följ max. tillåten belastning av möbeldelarna. Mer information finns i monteringsanvisningen
RO Respectați valorile de solicitare max. admise pentru corpurile de mobilier. Pentru detalii consultați instrucțiunile de montaj
ES Respete los valores máximos de carga admisibles para las piezas de los muebles. Consulte los detalles en las instrucciones

D CH AT LI LU Zur Möbelfeinigung ein mit Wasser befeuchtetes, fusselfreies Baumwolltuch verwenden. Geeignigte Flächen immer trockenreiben!
GB US To clean the furniture only use a water dampened lint-free cotton cloth. Once cleaned, always wipe the surfaces dry.
FR BE NC Utilisez un chiffon en coton non pelucheux humidifié avec de l'eau pour nettoyer les meubles. Séchez systématiquement les surfaces
NL nettoeëes en les frottant!
IT Gebuik een met water bevochtigde, pluivrije katoenen doek om de meubels te reinigen. Wrijf gereinigde oppervlakken altijd droog!
SI Per pulire il mobile utilizzare un panno di cotone inumidito d'acqua e che non perde pelucchi. Asciugare sempre le superfici che si sono
XS HR BA krpom!
HU Za čišćenje pohištna uporabljajte vlažno bombažno krpo, ki ne pušča vlaken. Očišćene površine vedno obrišite do suhnega!
BG За čišćenje namještaja koristite sa vodom navlaženu pamučnu krpu koja ne ispušta vlakna. Očišćene površine uvijek obrišite suhom
CZ SK K čištění nábytku používejte bavlněný hadr neuvloňující vlákna, navlhčený ve vodě. Učištěné plochy vždy utřete do sucha!
SE För möbelförpackning används en luddfri bomullsduk fuktad med vatten. Rengörda ytor ska alltid torftas torra!
RO Pentru curățarea mobilierului utilizați o lavetă din bumbac fără scame umezită cu apă. Suprafețele curățate se șterg întotdeauna până se usucă!
ES Emplee un paño de algodón humedecido con agua y libre de pelusa para la limpieza de los muebles. ¡Seque siempre las superficies que ha limpiado!