

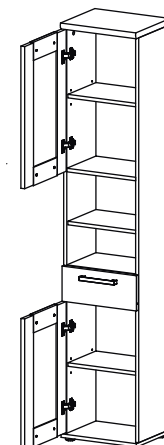

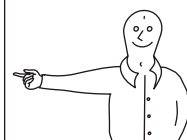

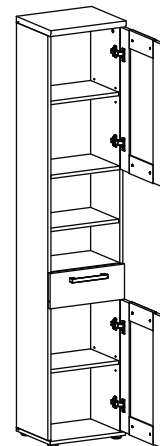

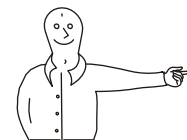

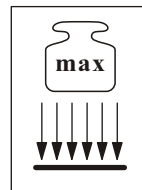
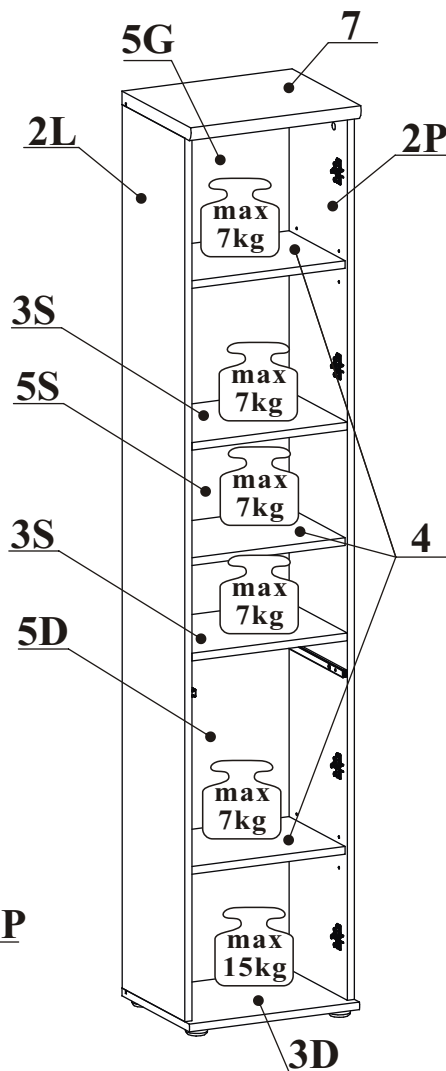
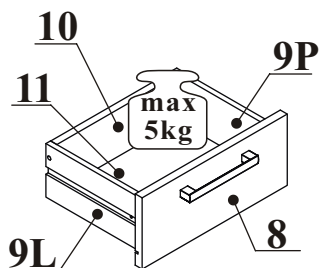
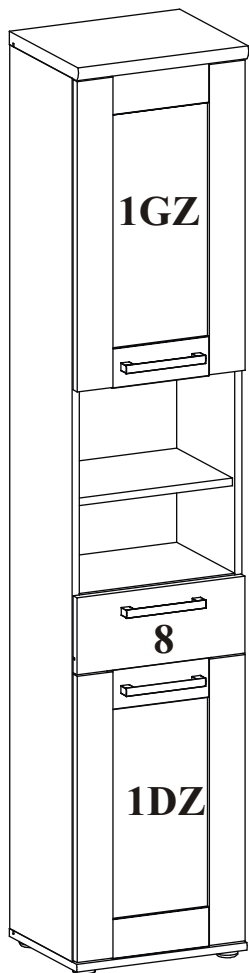
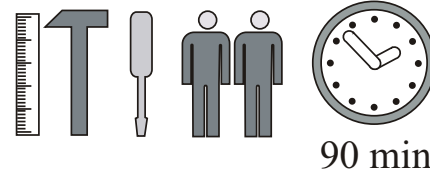

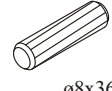
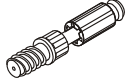

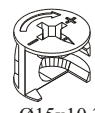

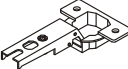
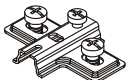

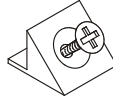



# ROMANCE 70-356-\_\_-6



NO	Dim.		Col.-No	Qty
1DZ	596	376	1	1
1GZ	646	376	1	1
2L	1840	284	1	1
2P	1840	284	1	1
3D	381	307	1	1
3S	348	264	1	2
4	348	254	1	3
5D	763	360	1	1
5S	439	360	1	1
5G	650	360	1	1
7	381	314	1	1
8	376	160	1	1
9L	250	120	1	1
9P	250	120	1	1
10	315	106	1	1
11	255	326	1	1

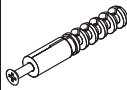
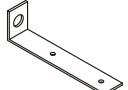

90 min

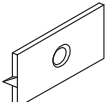
A1 x20  ø8x36	B4 x14 	B5 x12  ø15x12	G5 x12 	B7 x2  Ø15x10,3	G8 x2  Ø20
E21 x4 Ø35  H=0	E2 x4  H=0	D10 x10  USØ3,5x13	S1 x15 	B11 x6  Ø7x50	G4 x6 
H6 x1  L=250mm.	D18 x2  M4x9	D20 x4  ESØ6x9,5	UP13 x16  UPØ3x16	CN1 x3  L=160mm	UP16 x6  UPØ4x35
I11 x4  Ø45, h=15	D11 x4  USØ3,5x25	G7 x12 	Z2 x12  Ø5	KR1 x1 	L1 x1 
G2 x1 	G16 x6 				

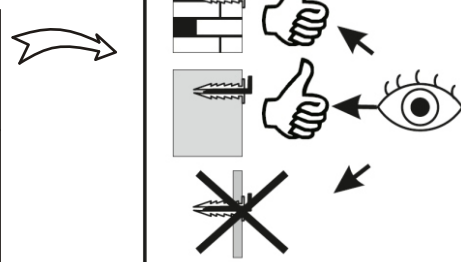
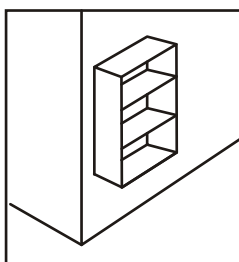
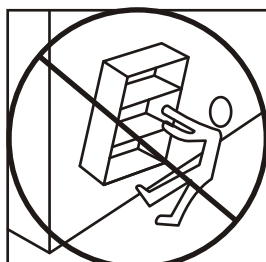
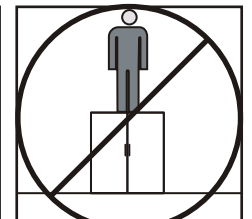
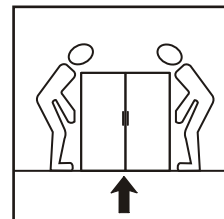
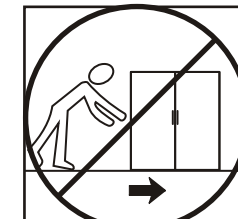
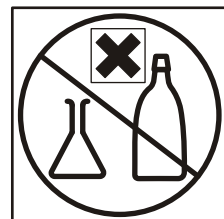
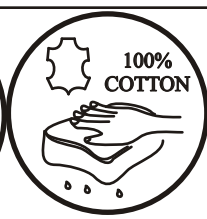
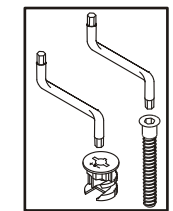
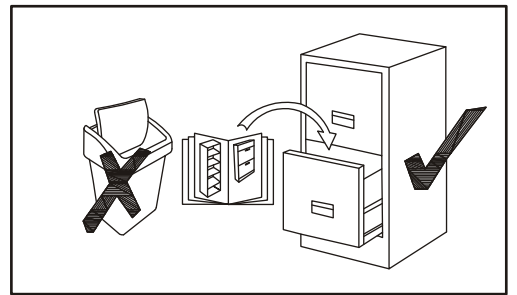
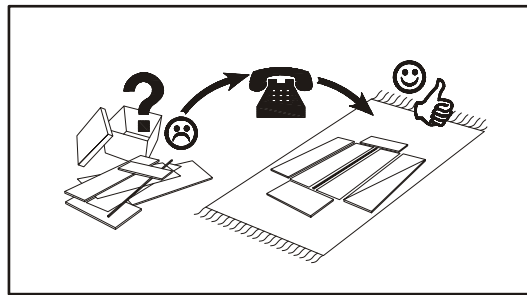
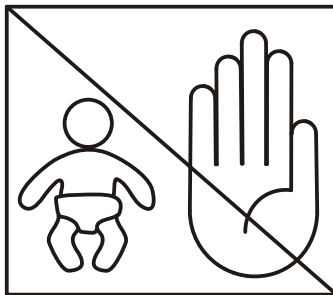
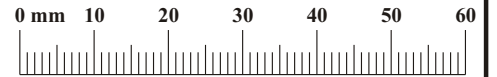

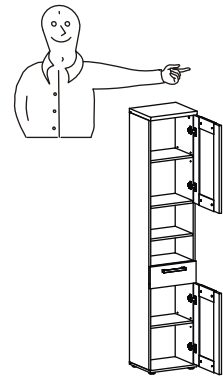

1

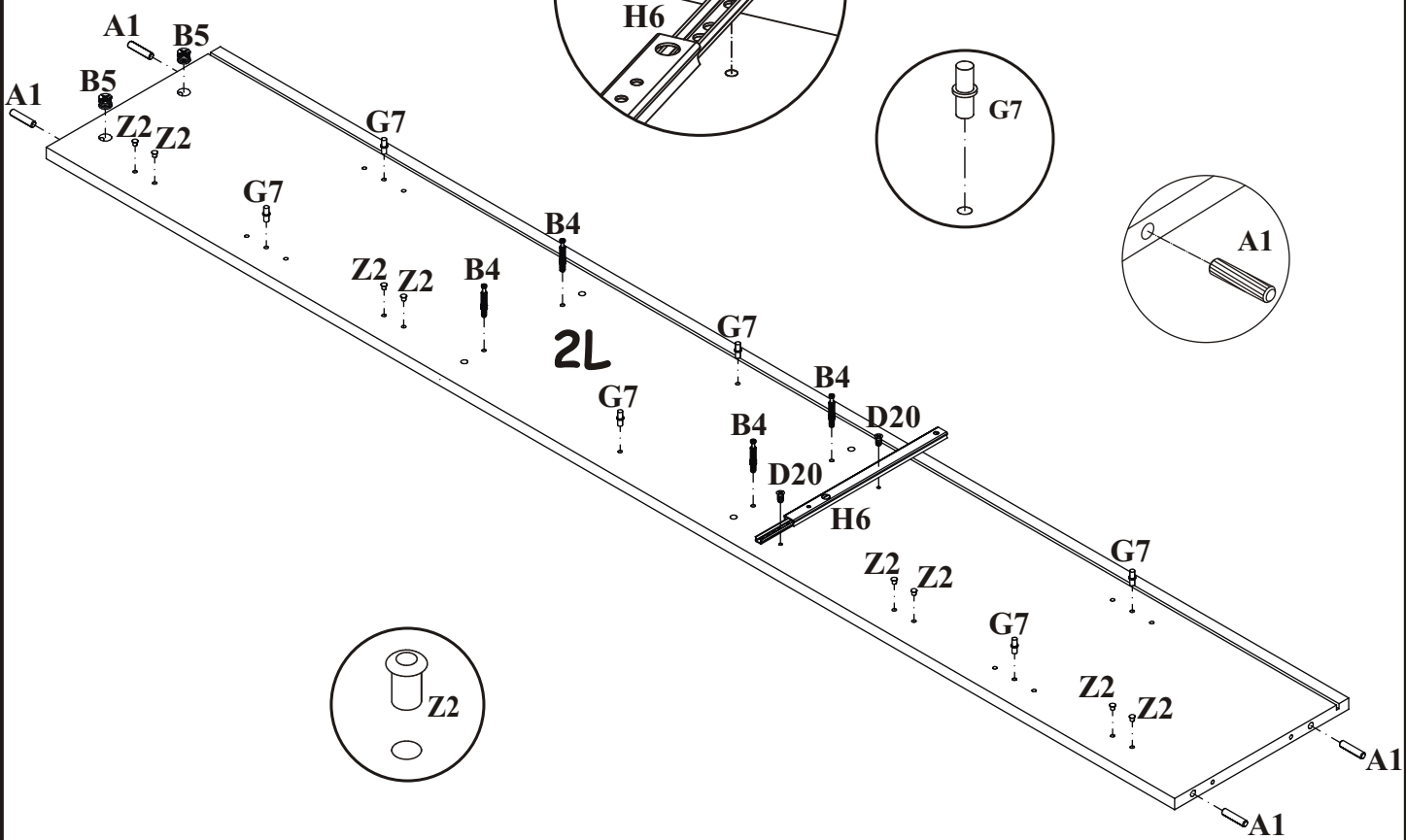
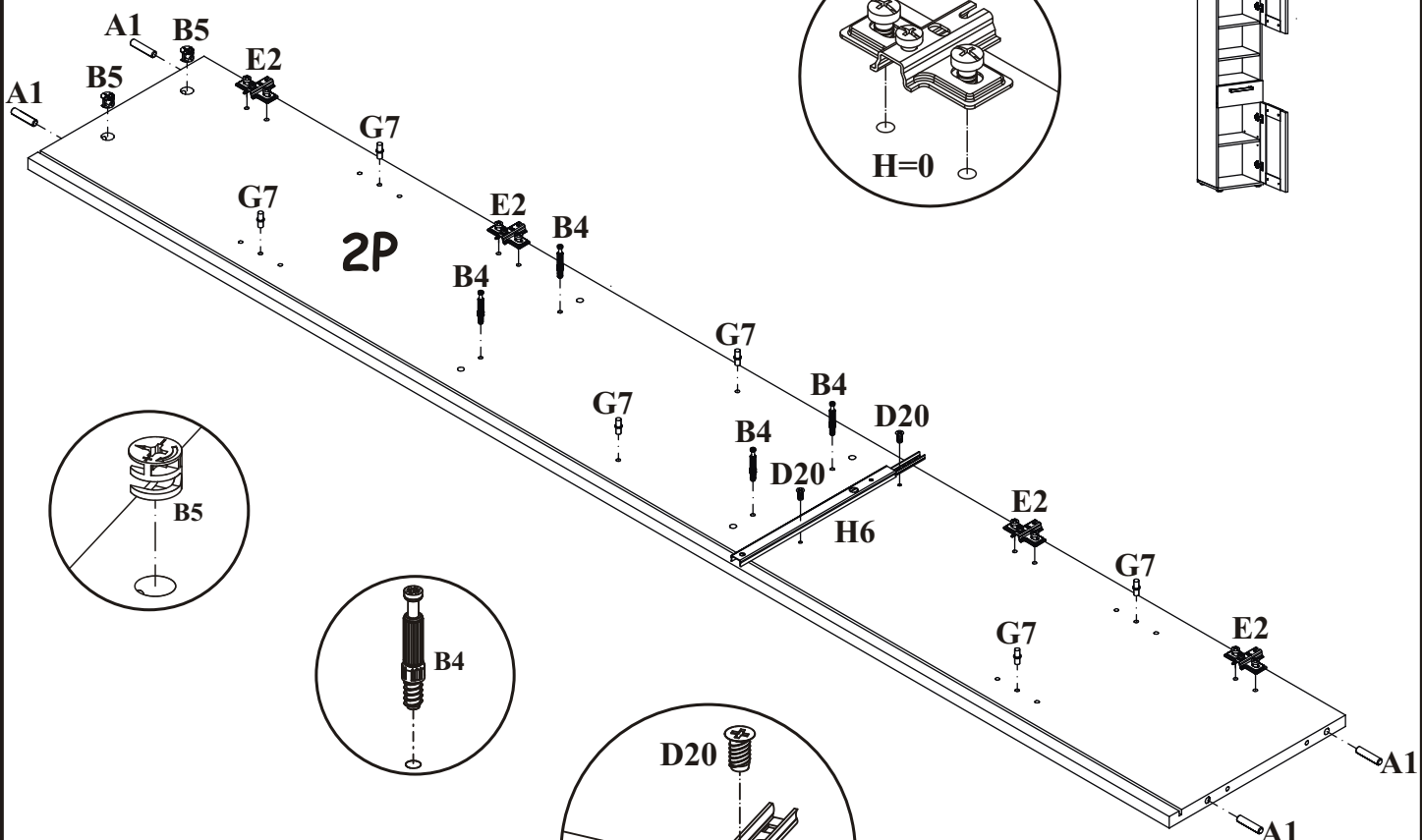

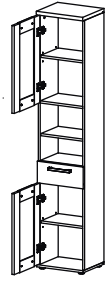
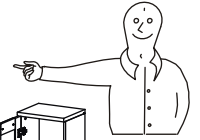

1

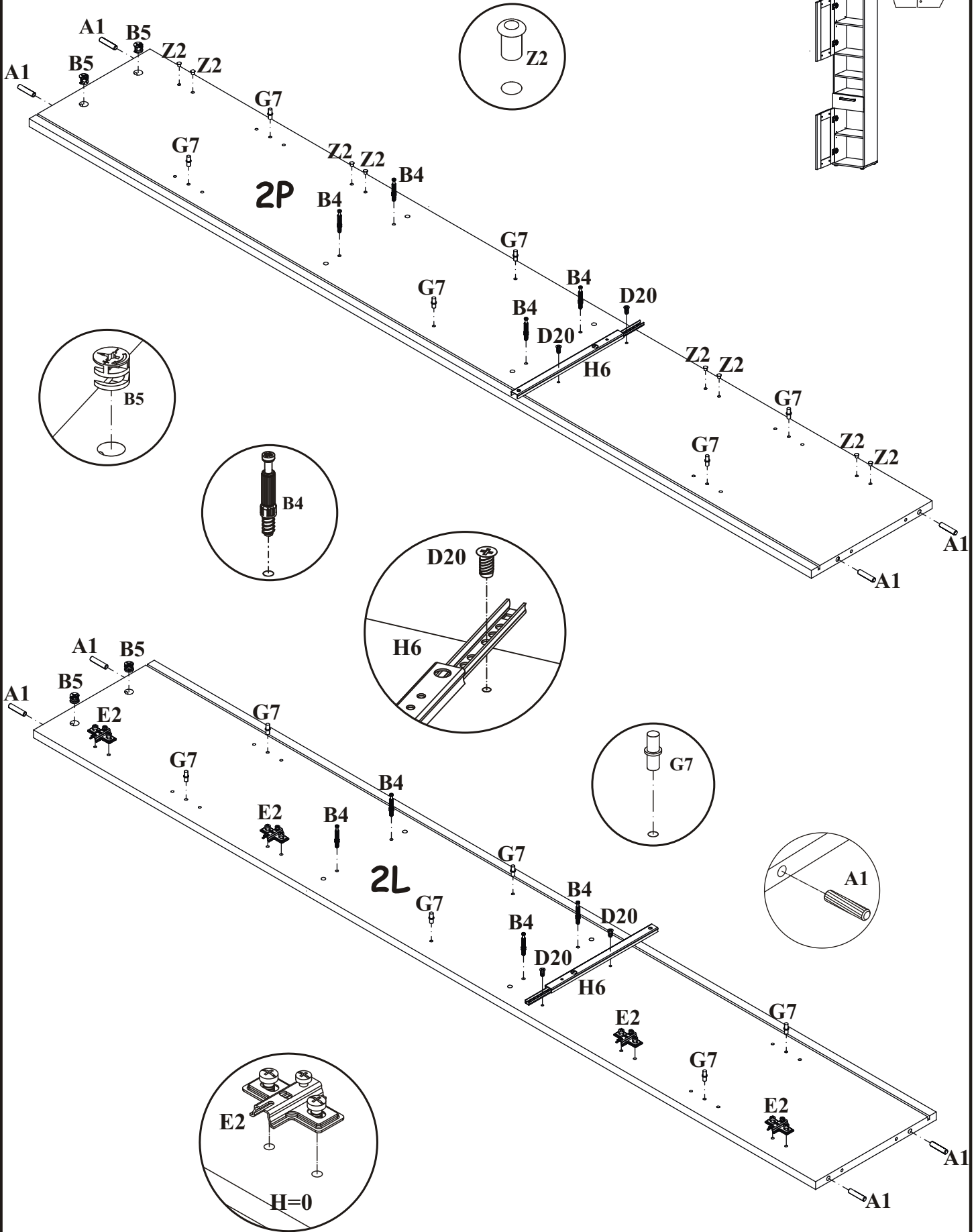

2

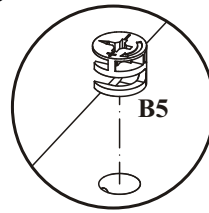
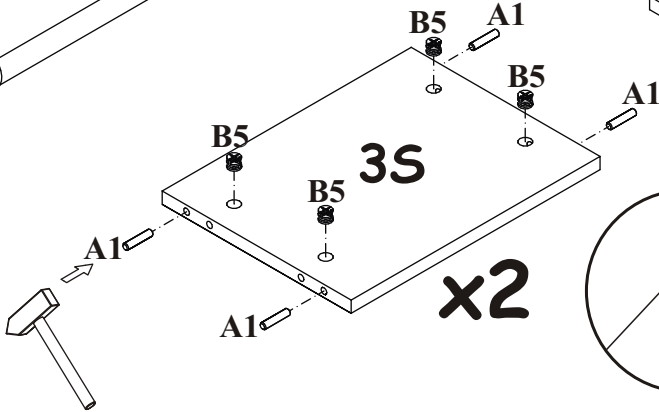
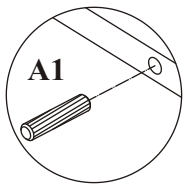
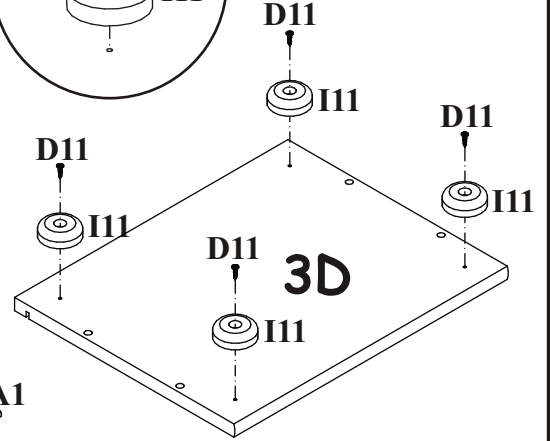
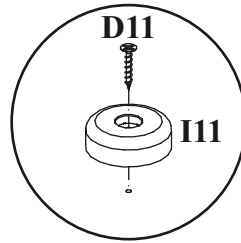
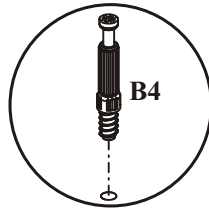
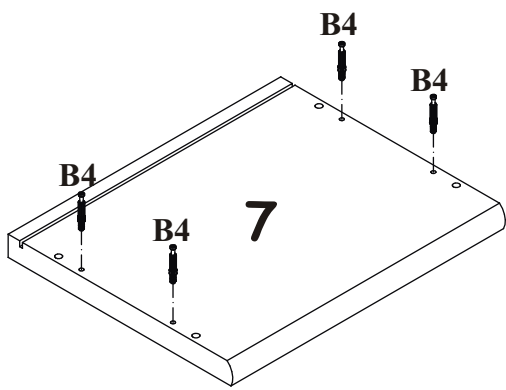

3

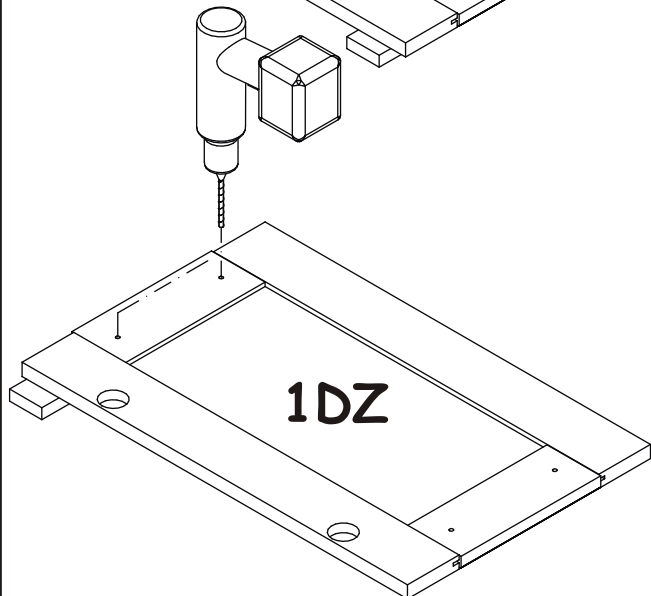
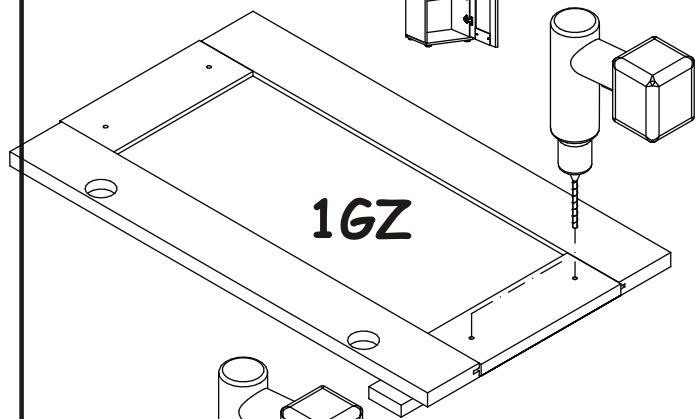
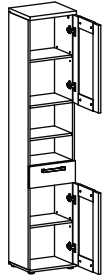
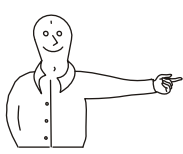

3

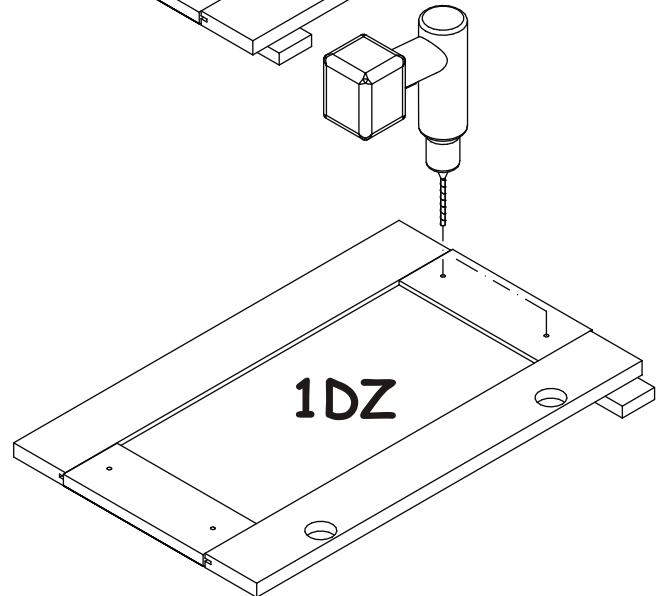
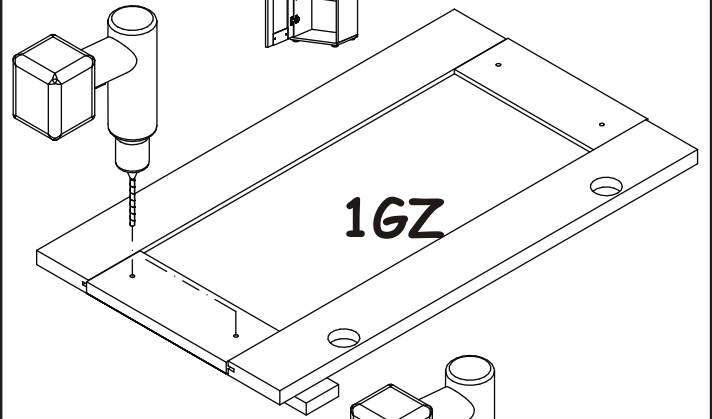
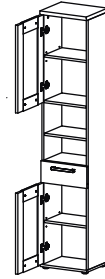
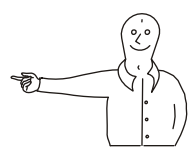

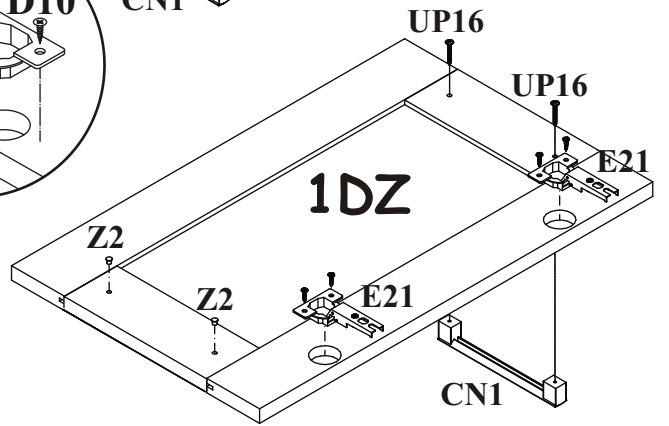
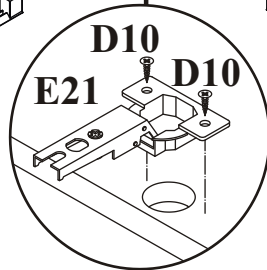
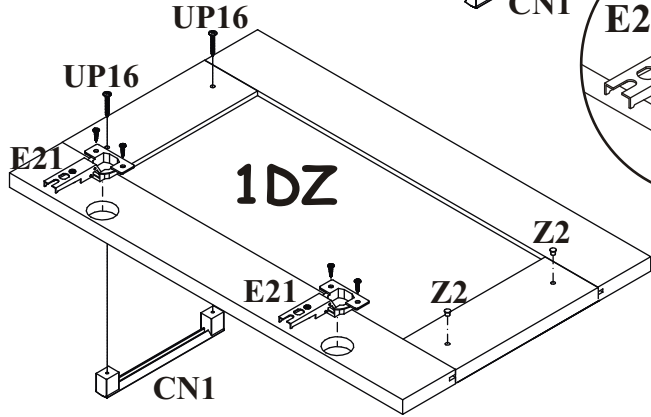
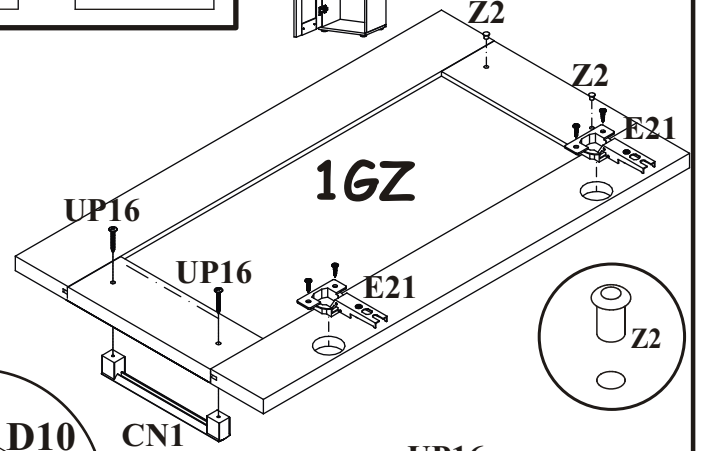
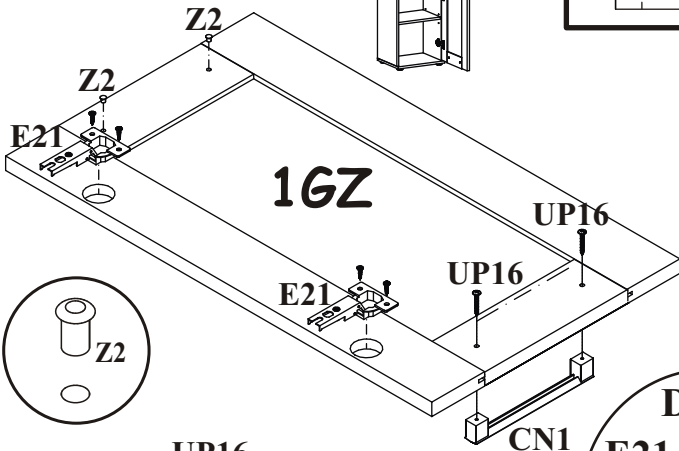
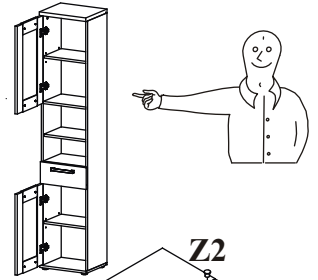
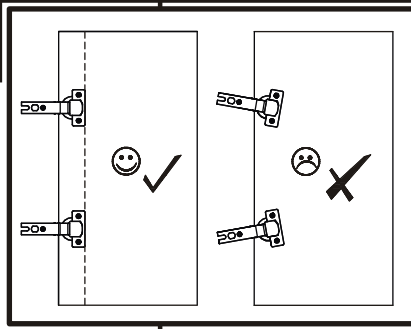
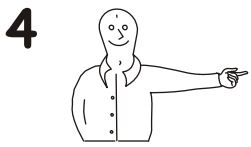

5

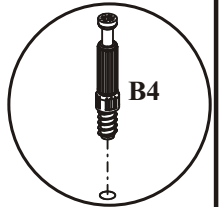
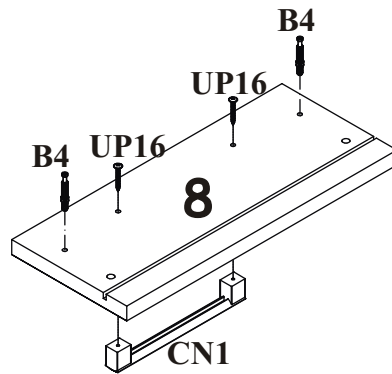
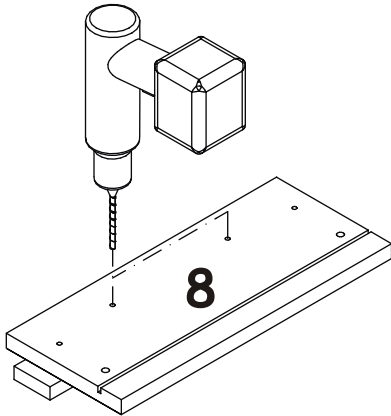

6

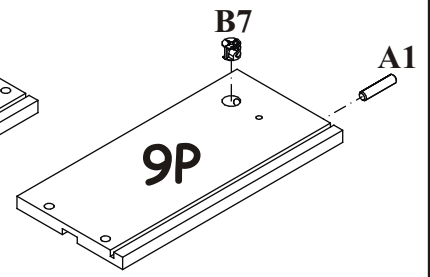
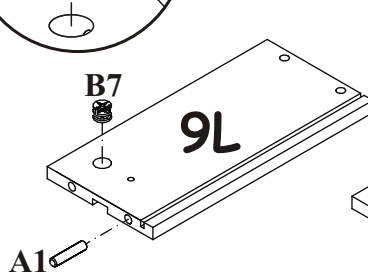
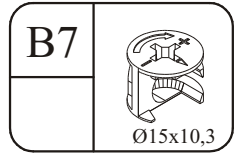
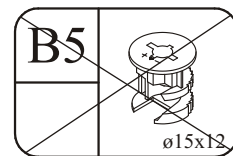
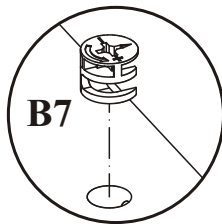
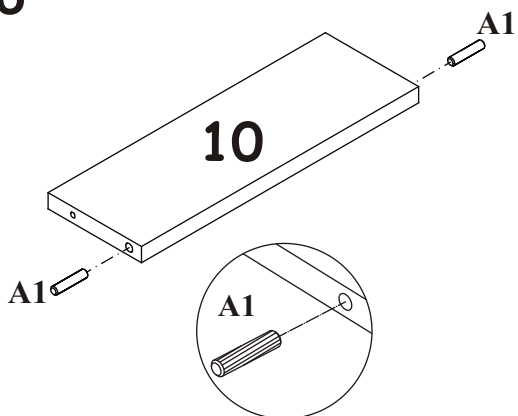

7

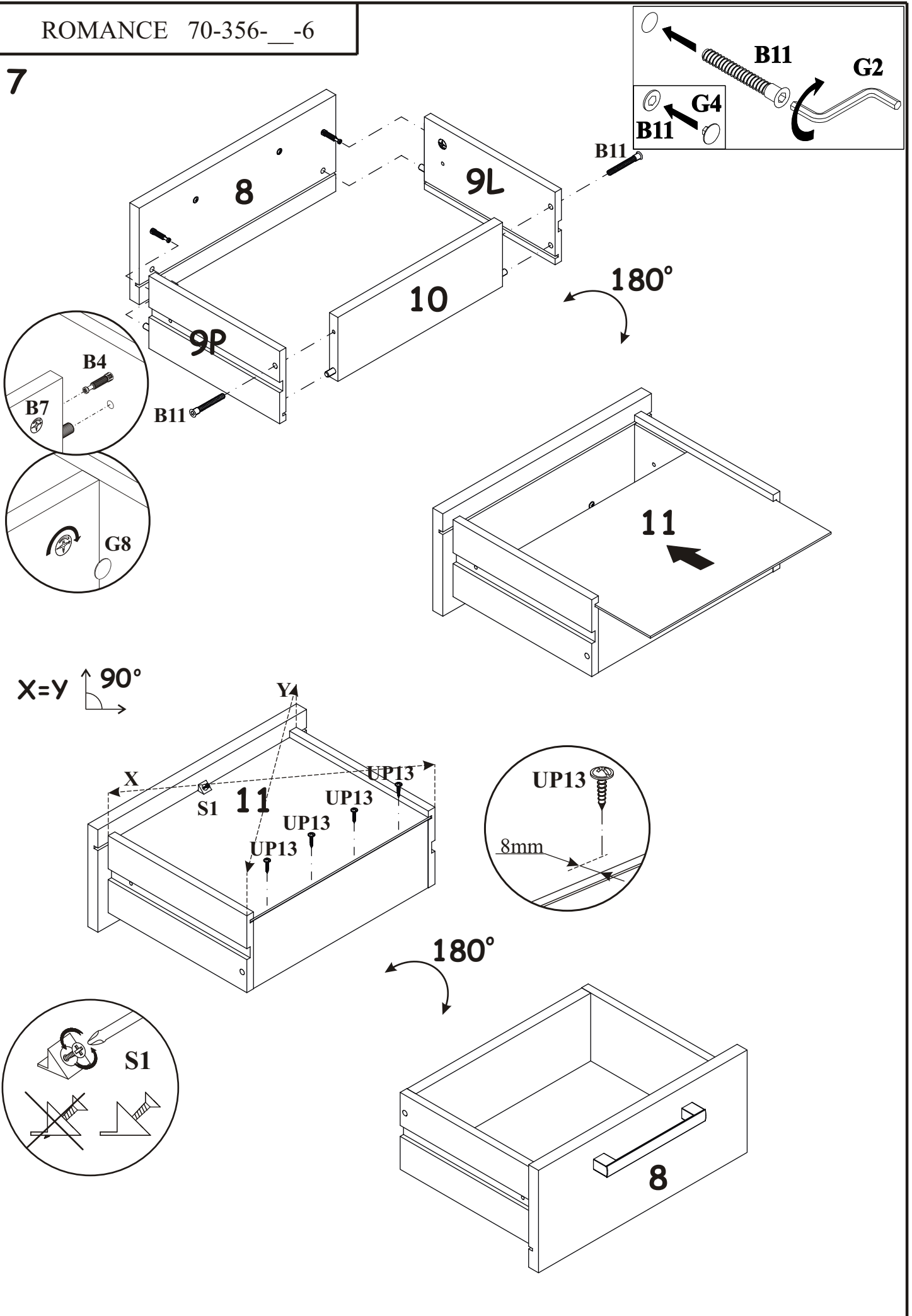

8

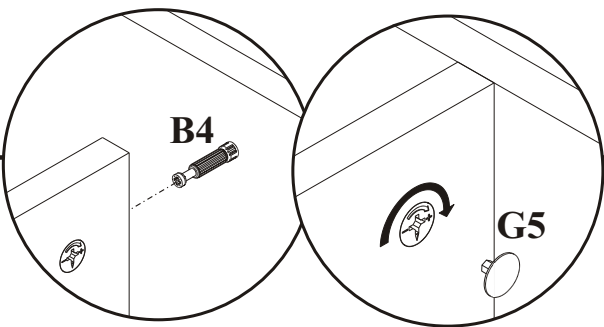
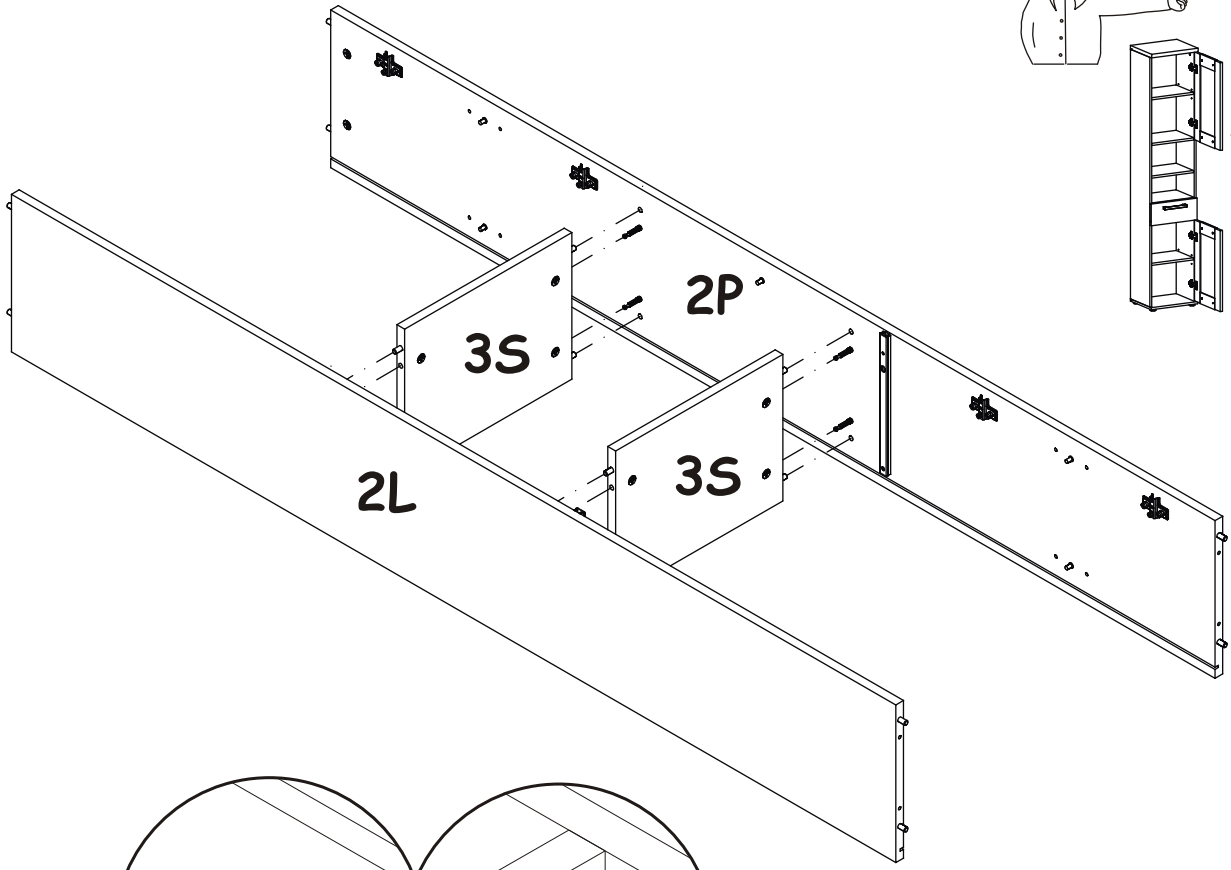
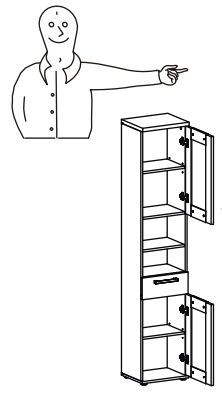

8

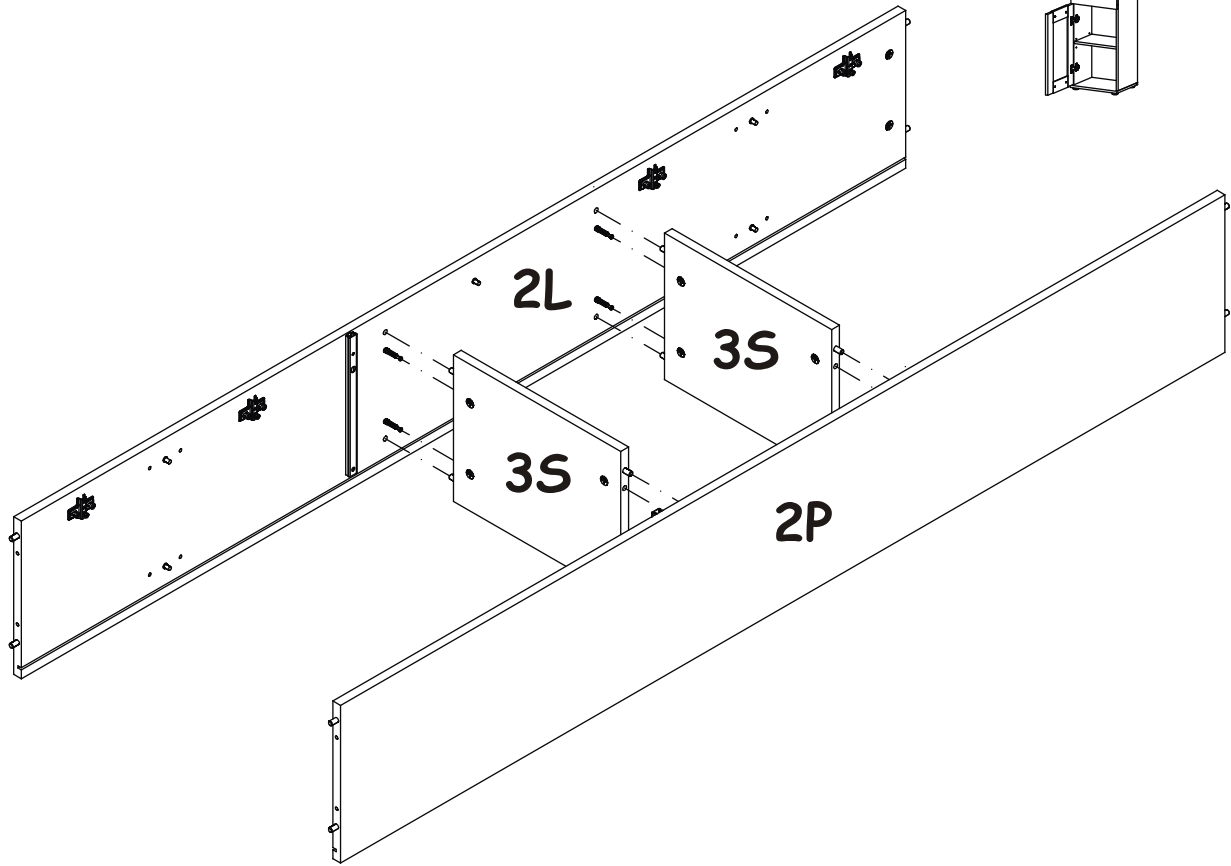
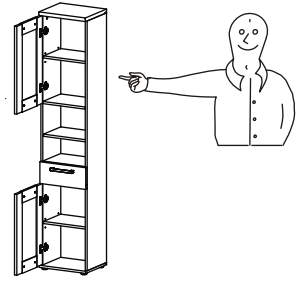



9

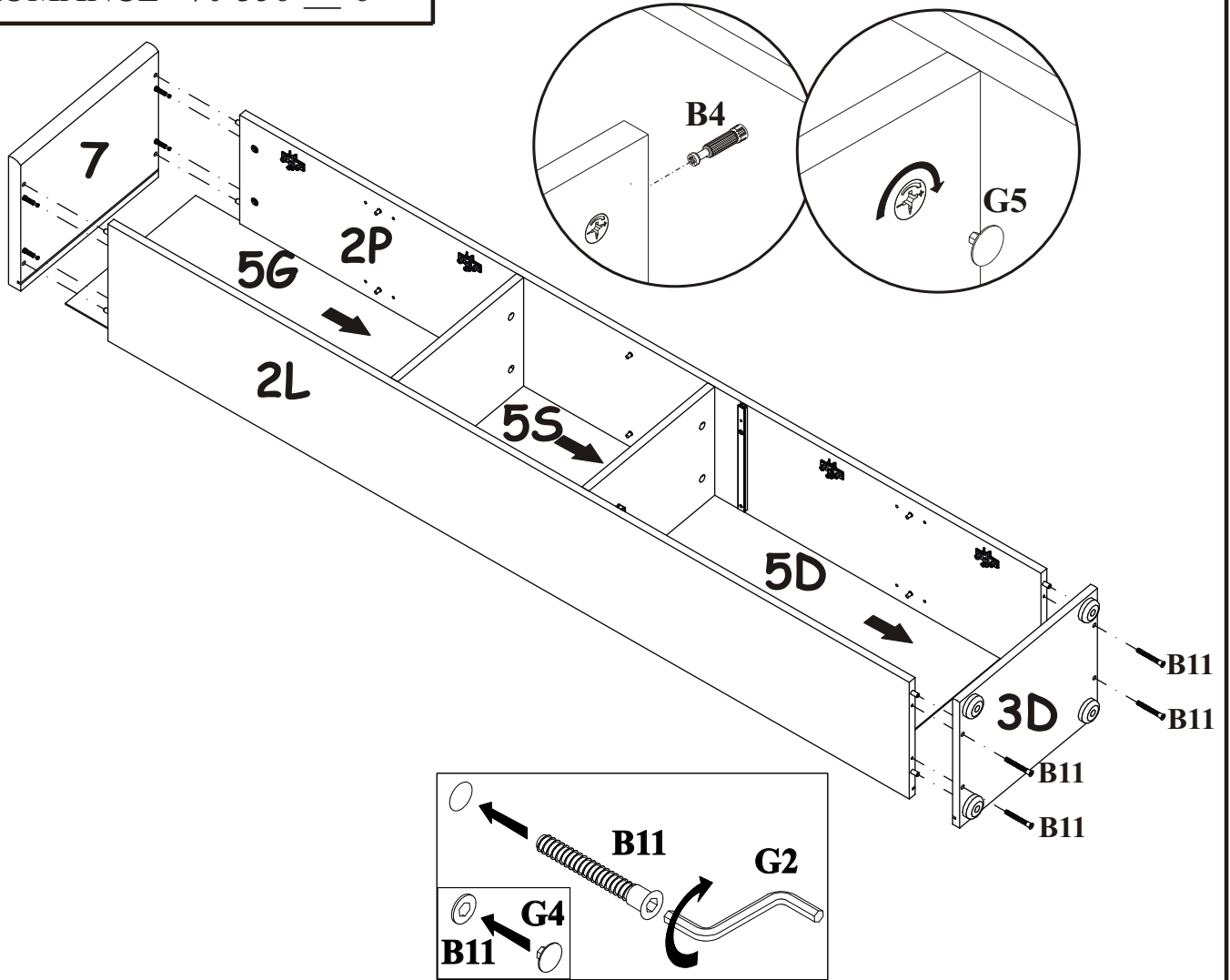

10

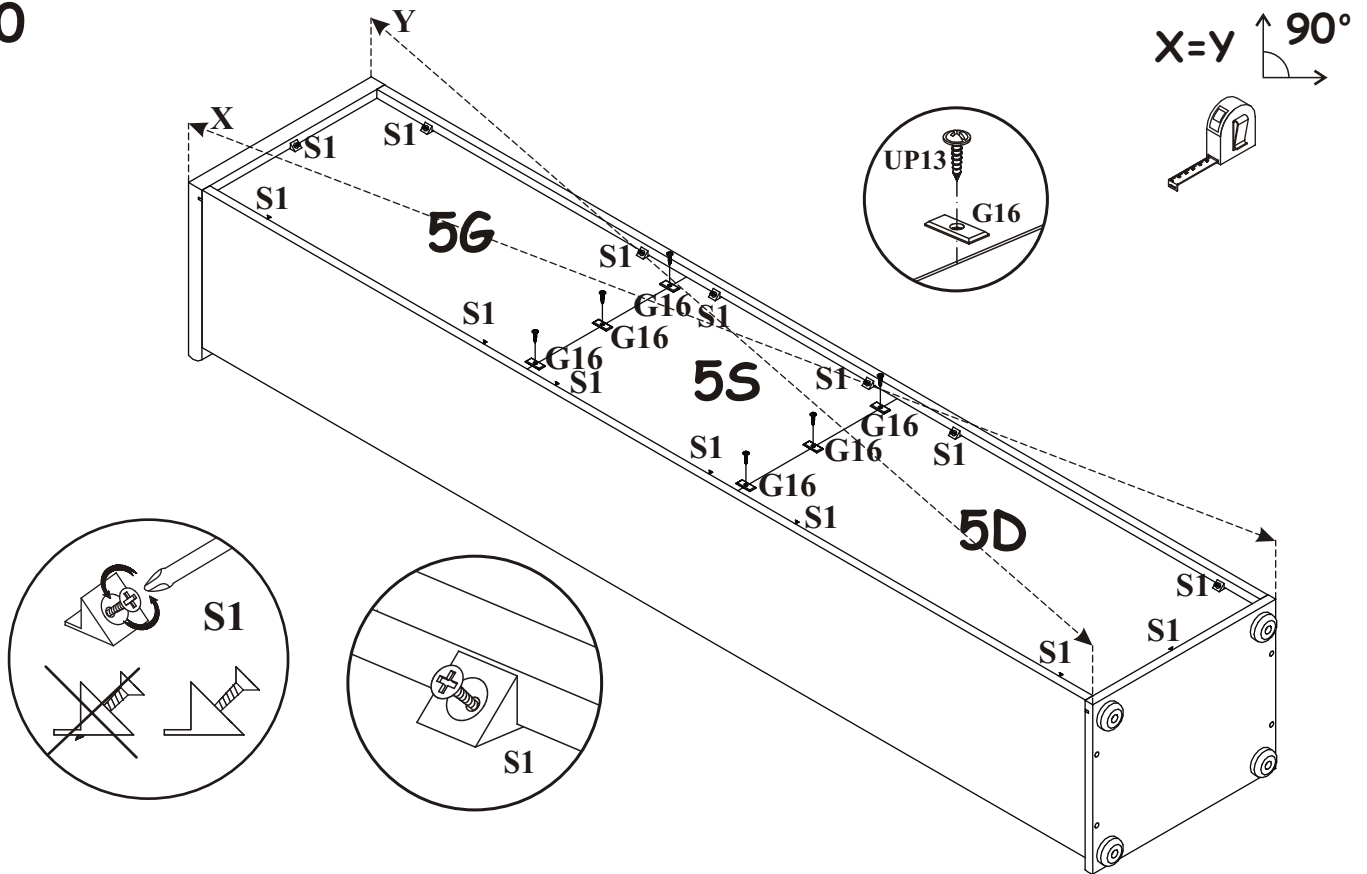

11

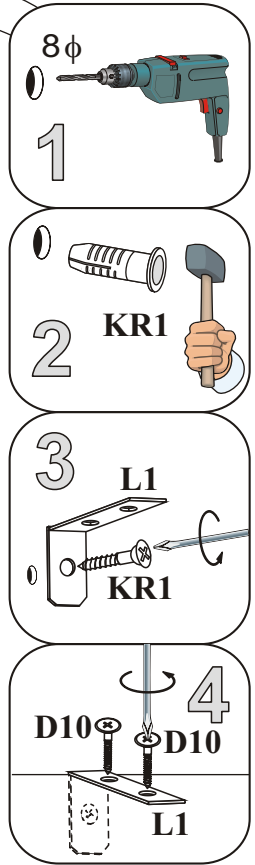
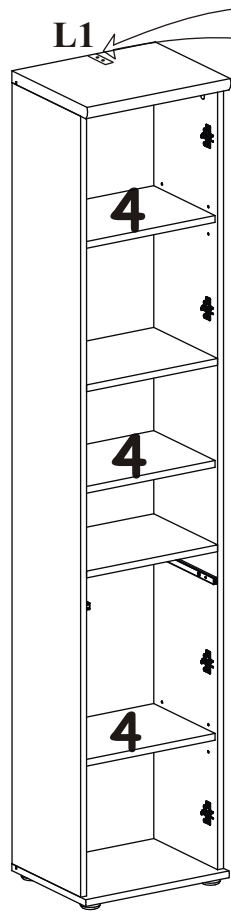
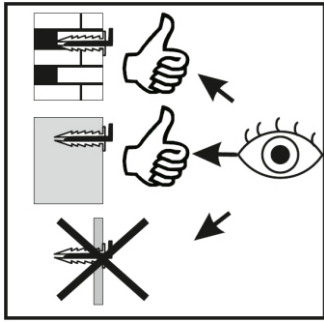

12

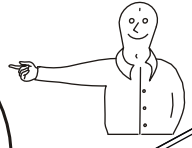
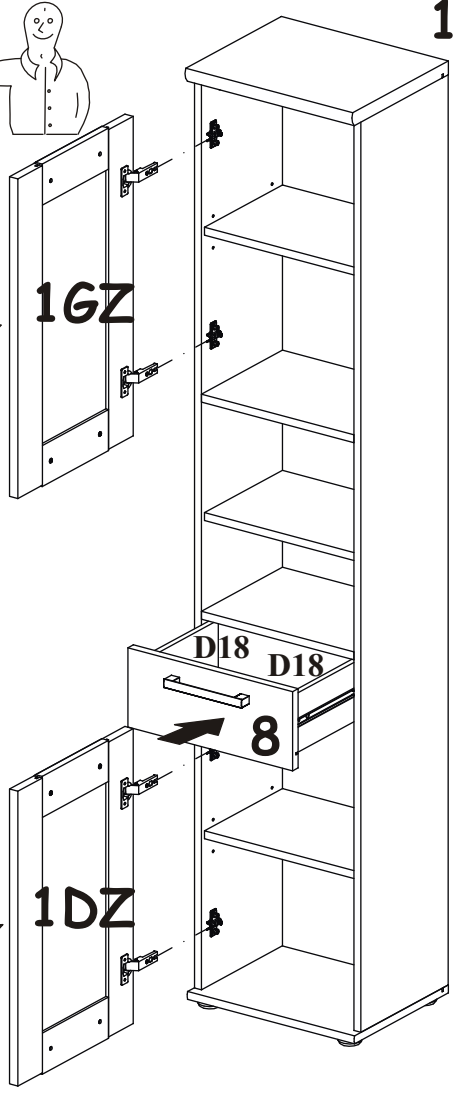
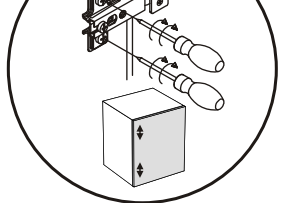
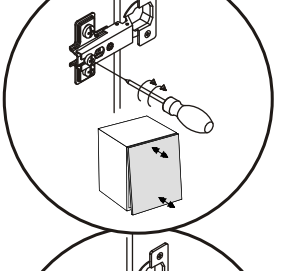
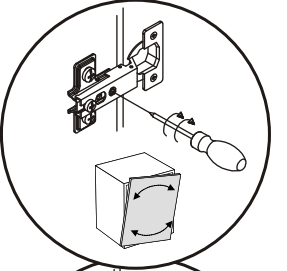
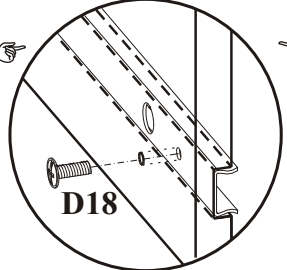
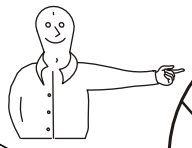
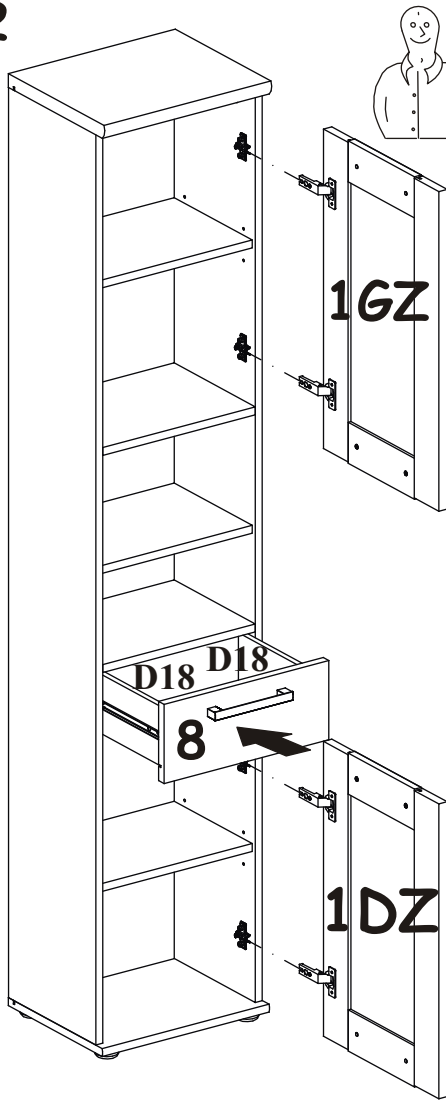

12