

069664

- ① x 12
- ② x 4
- ③ x 4
- ④ x 4
- ⑤ x 1
- ⑥ x 1

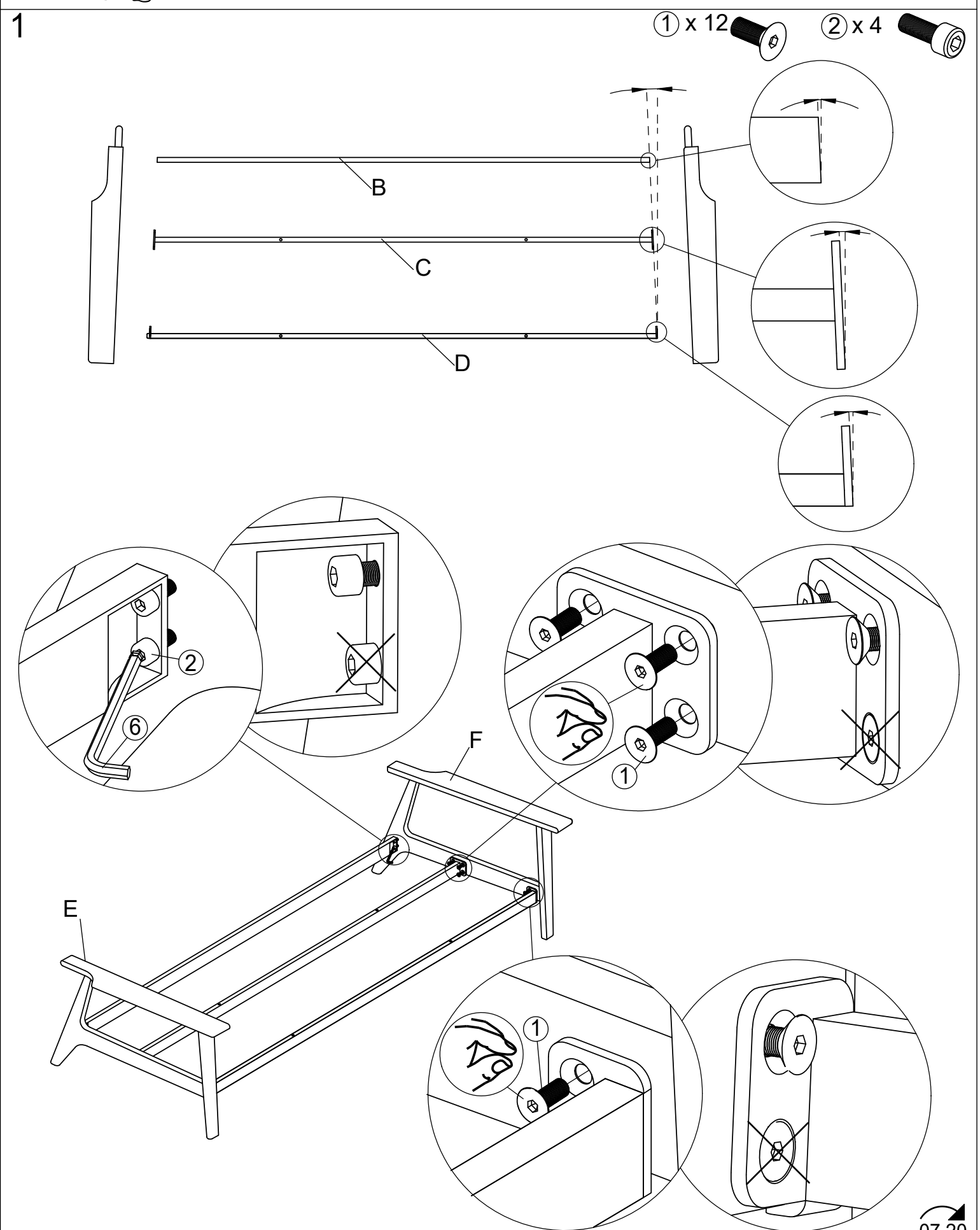

2

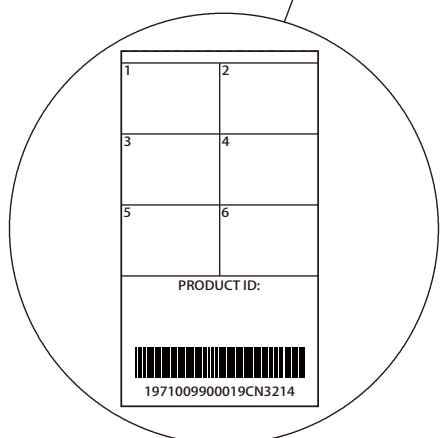
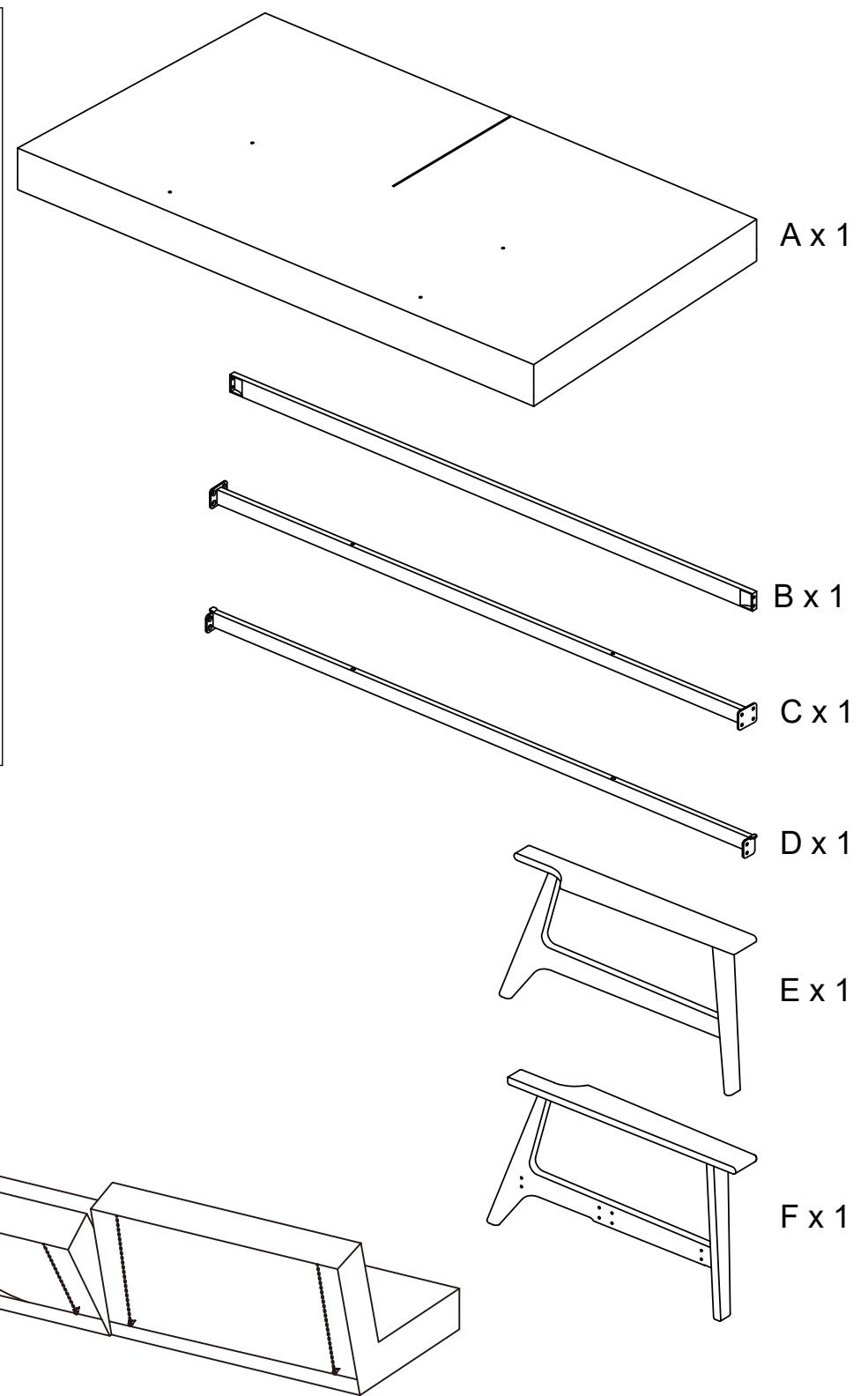
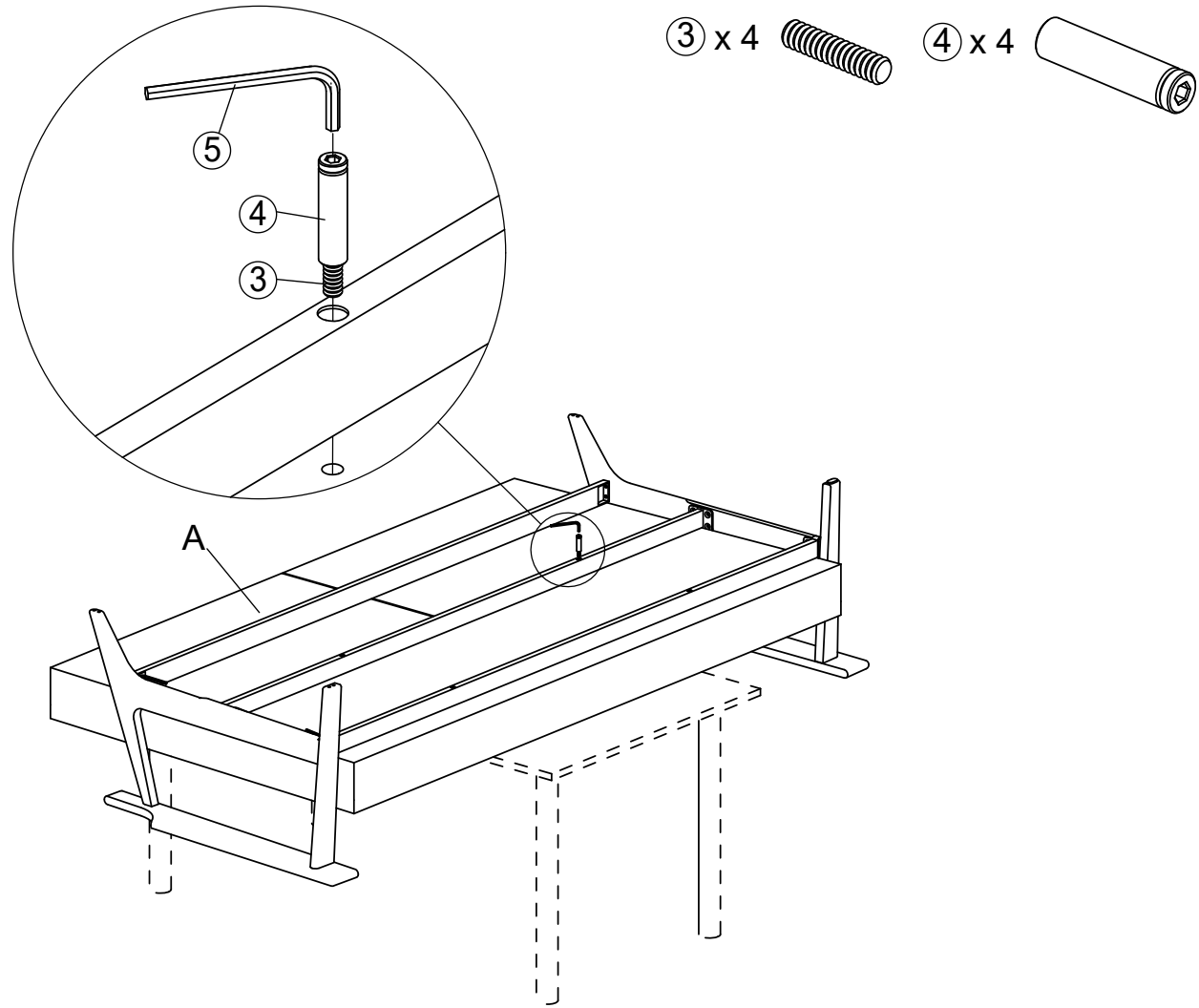

1

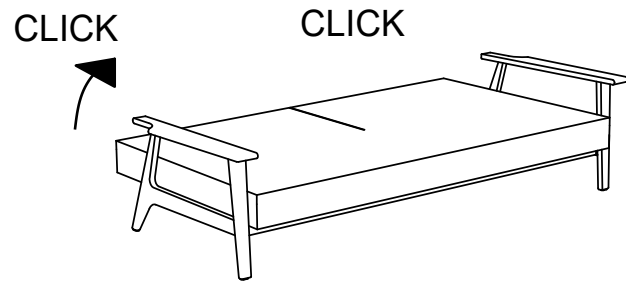

SOVE - SCHLAFEN - SLEEP - DORMIR

2

069664

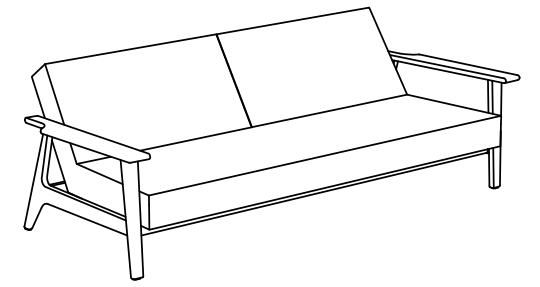

HVILE - RUHE - RELAX - REPOSER

3

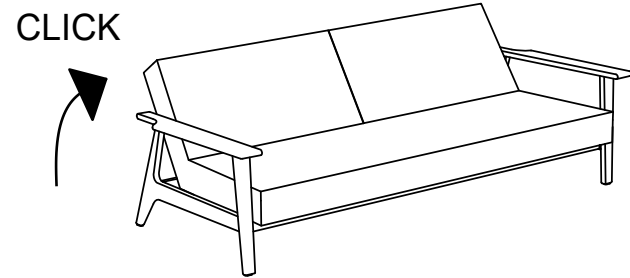

HVILE - RUHE - RELAX - REPOSER

4

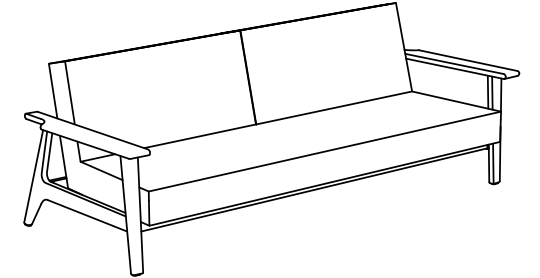

SIDDE - SITZEN - SIT - ASSISE

3

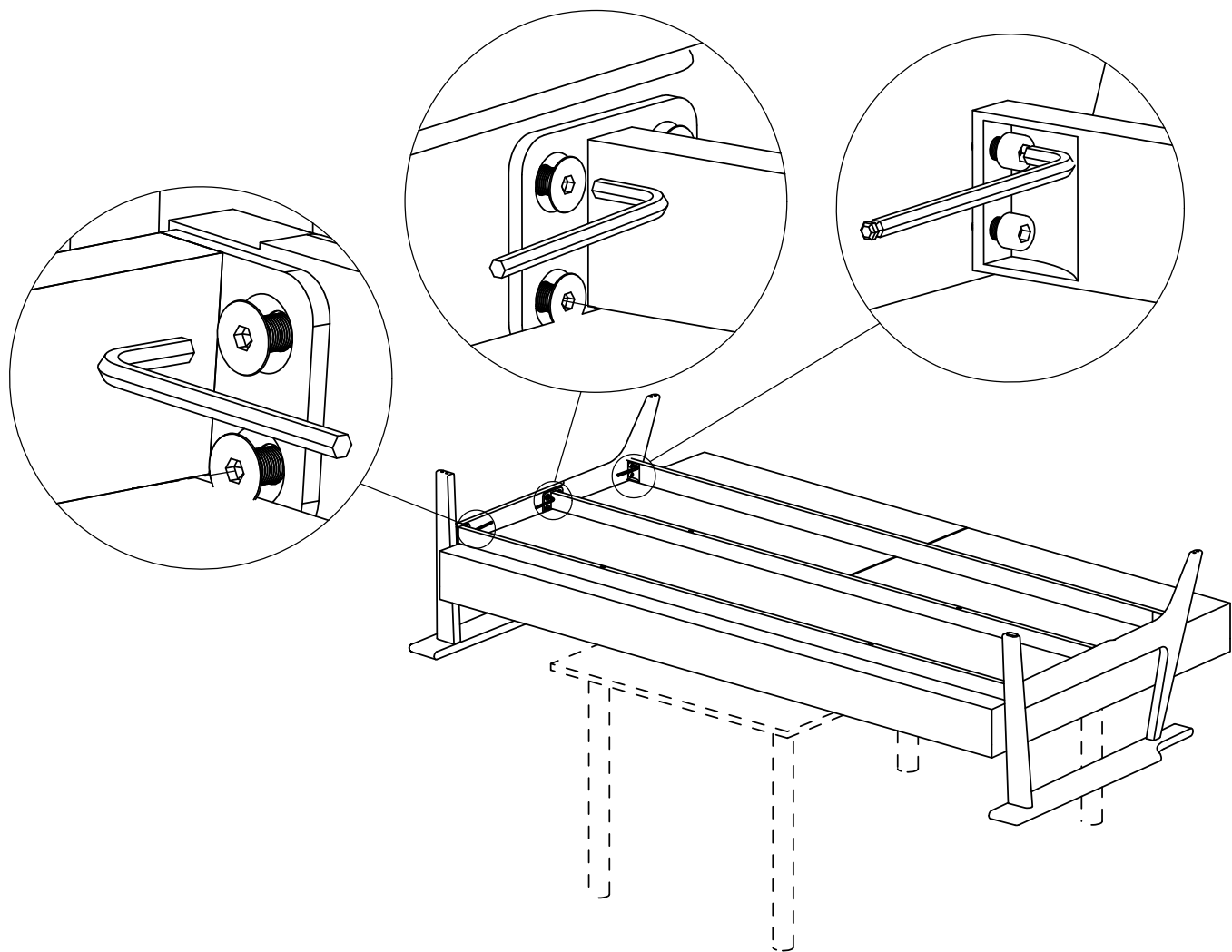

5

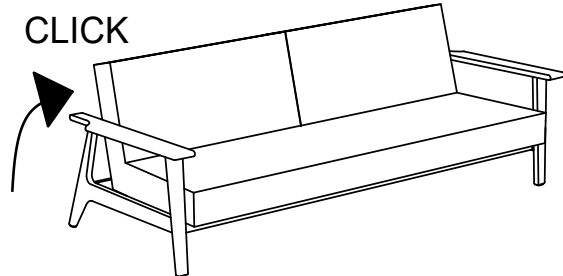

SIDDE - SITZEN - SIT - ASSISE

6

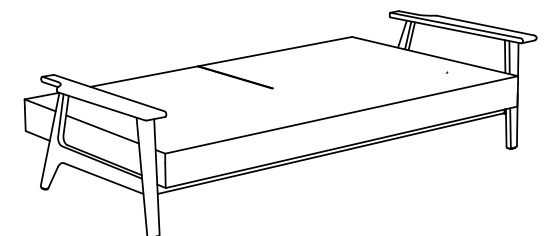

SOVE - SCHLAFEN - SLEEP - DORMIR

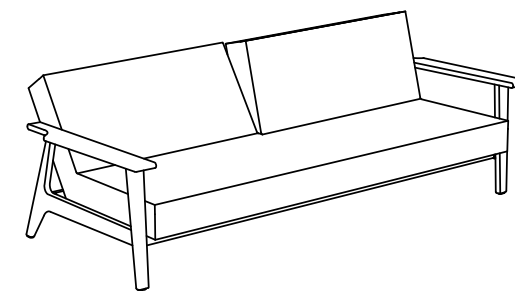

HVILE - RUHE - RELAX - REPOSER / SIDDE - SITZEN - SIT - ASSISE